



# IJF Grand Slam Moscow 2009

(RUS Moscow, 30-31 May 2009)

# -60 kg

24 Judoka

Pool A

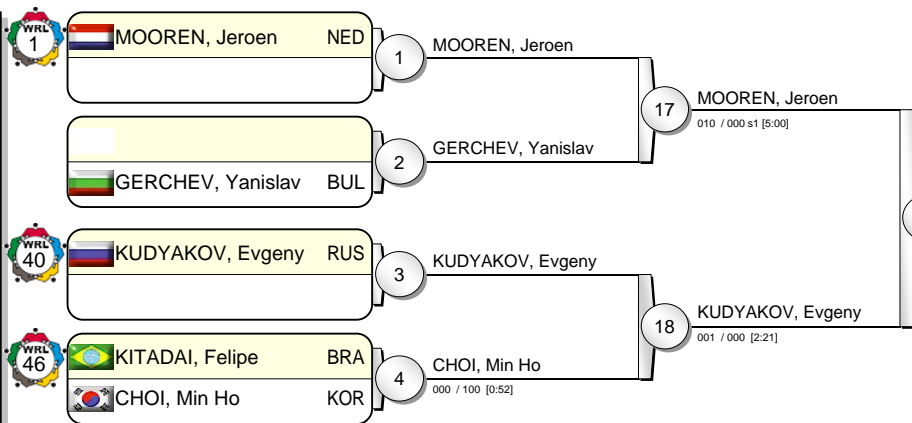

Pool B

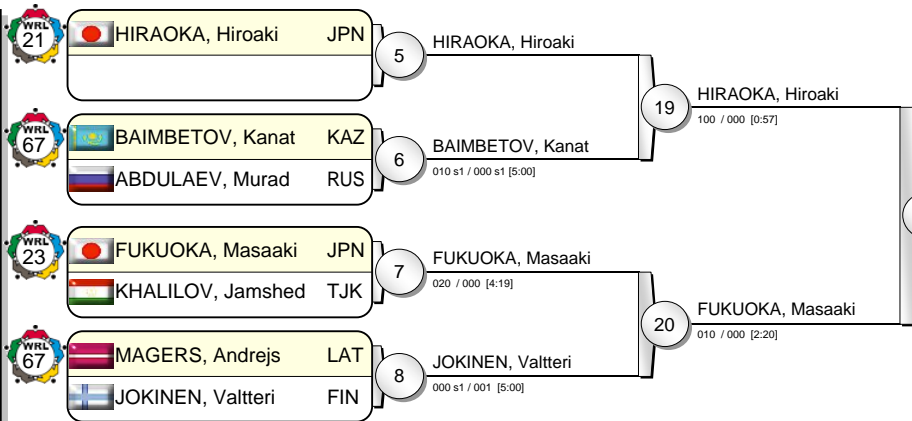

Pool C

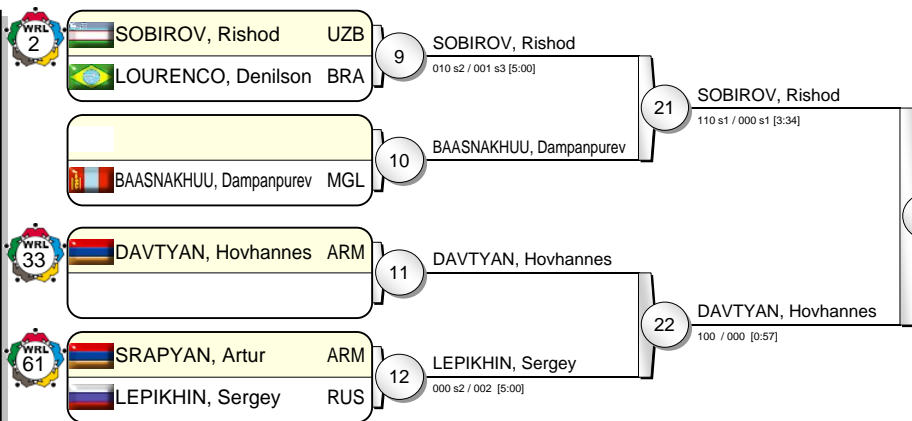

Pool D

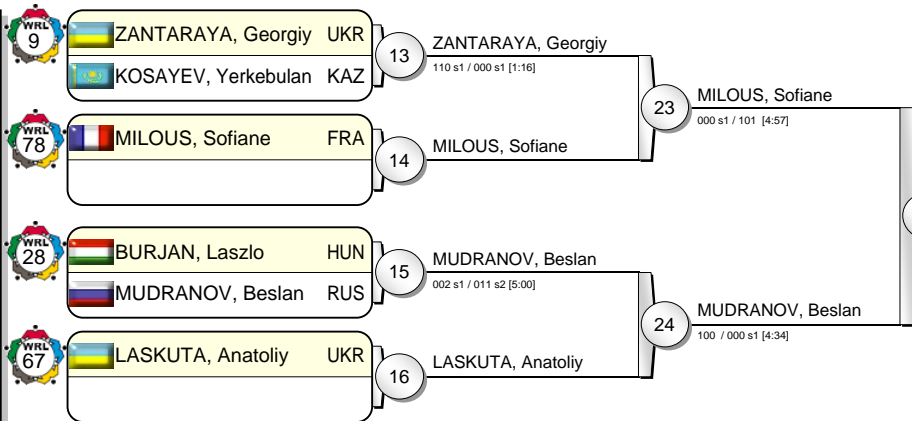

DAVTYAN, Hovhannes ARM 31 [000 / 001 [2:26]]

## Results

- |                       |     |  |
|-----------------------|-----|--|
| 1. DAVTYAN, Hovhannes | ARM |  |
| 2. FUKUOKA, Masaaki   | JPN |  |
| 3. KUDYAKOV, Evgeny   | RUS |  |
| 3. MUDRANOV, Beslan   | RUS |  |
| 5. MOOREN, Jeroen     | NED |  |
| 5. HIRAOKA, Hiroaki   | JPN |  |
| 5. SOBIROV, Rishod    | UZB |  |
| 5. MILOUS, Sofiane    | FRA |  |



www.r-r-g.ru



# IJF Grand Slam Moscow 2009

(RUS Moscow, 30-31 May 2009)

# -66 kg

26 Judoka

Pool A

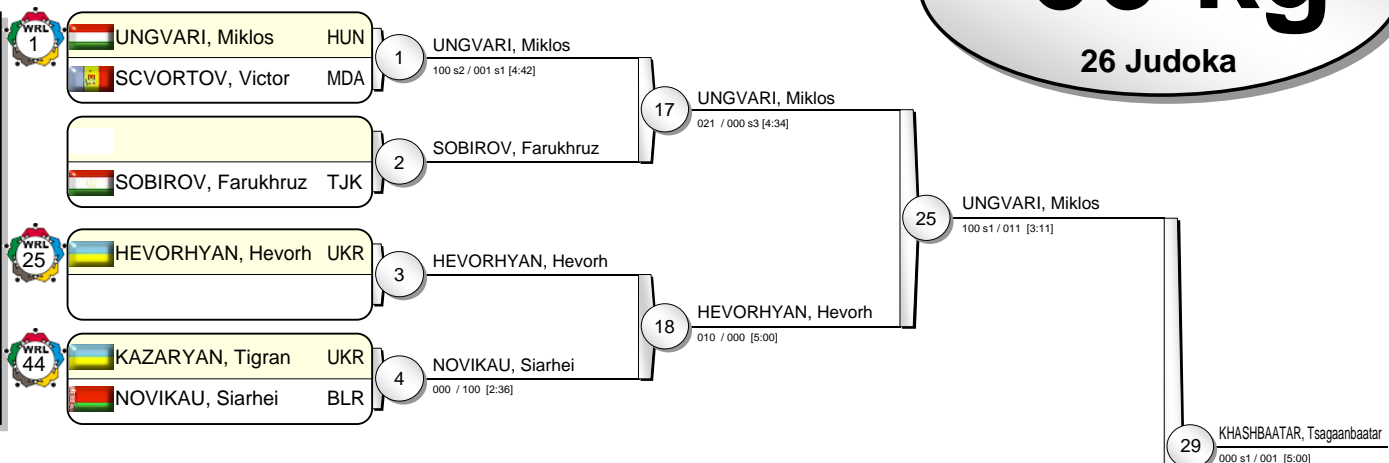

Pool B

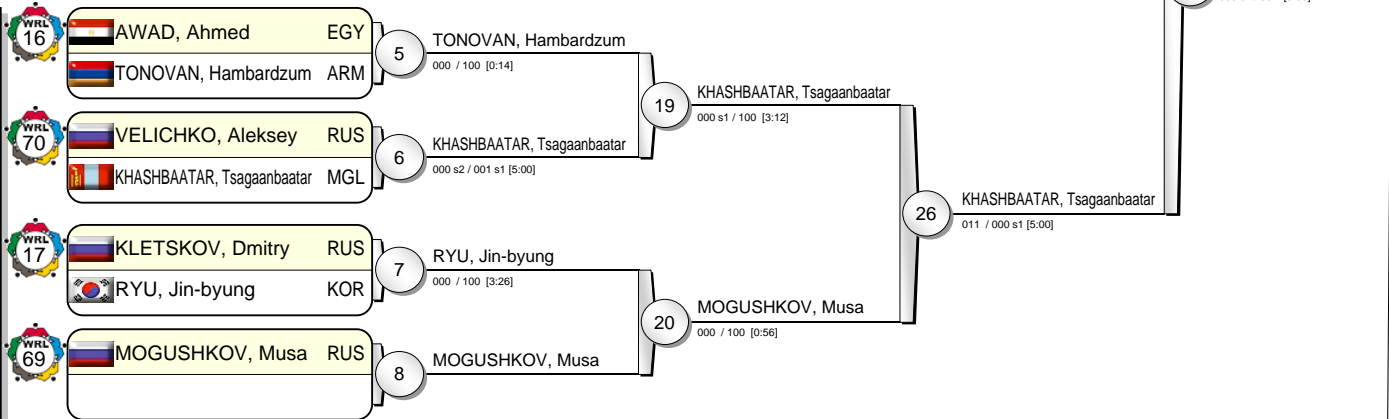

Pool C

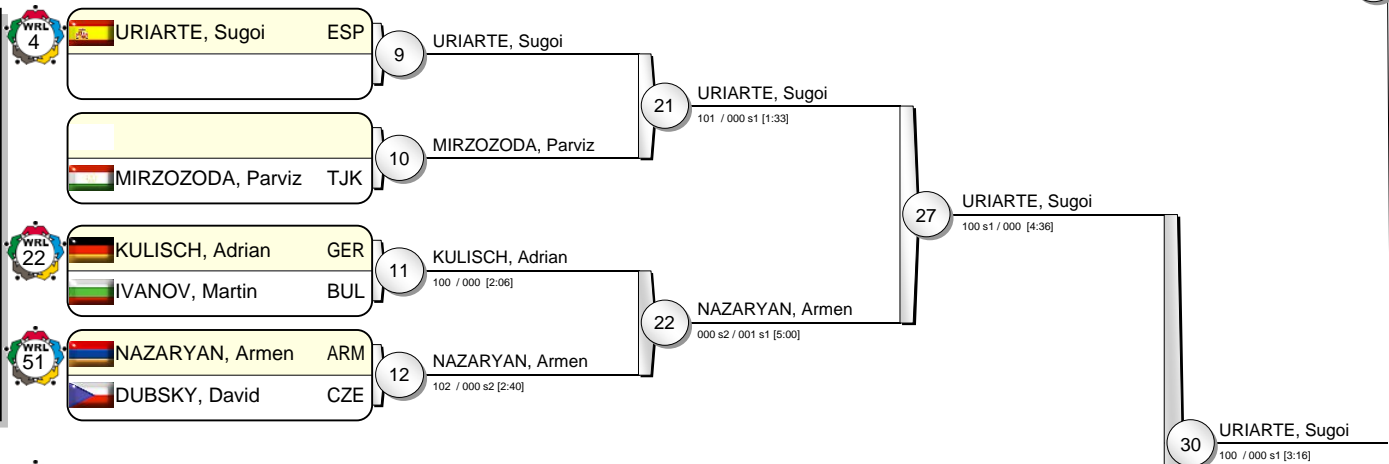

Pool D

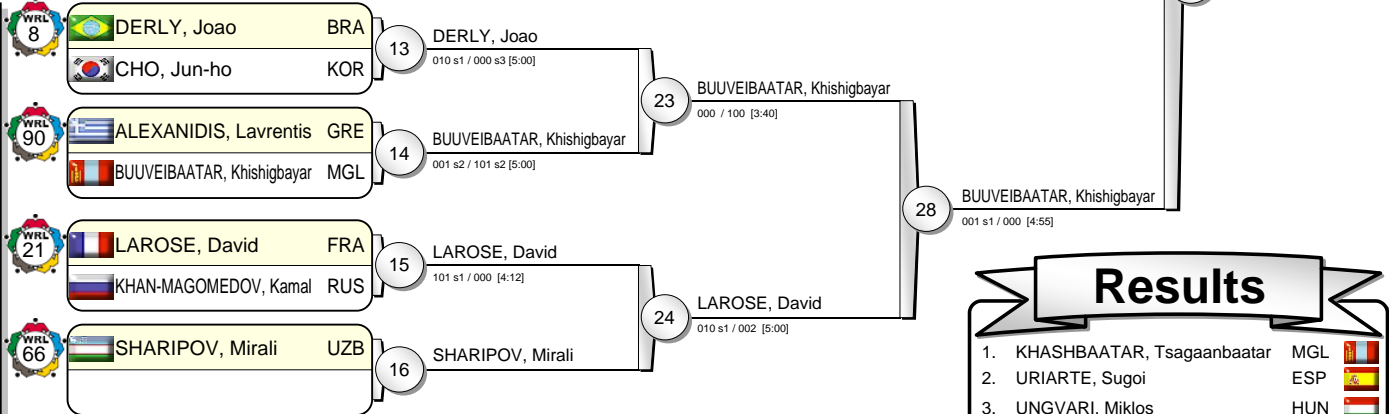

## Results

1. KHASHBAATAR, Tsagaanbaatar MGL
2. URIARTE, Sugoi ESP
3. UNGVARI, Miklos HUN
3. BUUVEIBAATAR, Khishigbayar MGL
5. HEVORHYAN, Hevorh UKR
5. MOGUSHKOV, Musa RUS
5. NAZARYAN, Armen ARM
5. LAROSE, David FRA





# IJF Grand Slam Moscow 2009

(RUS Moscow, 30-31 May 2009)

# -73 kg

35 Judoka

Pool A

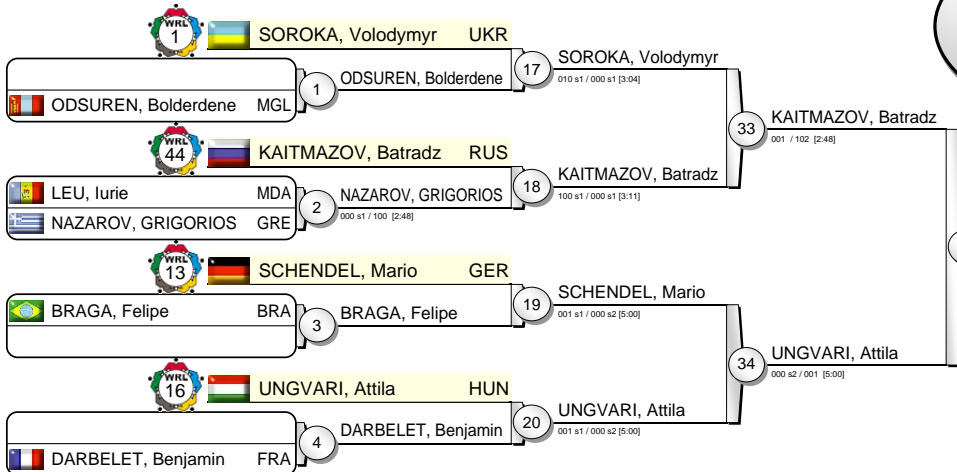

Pool B

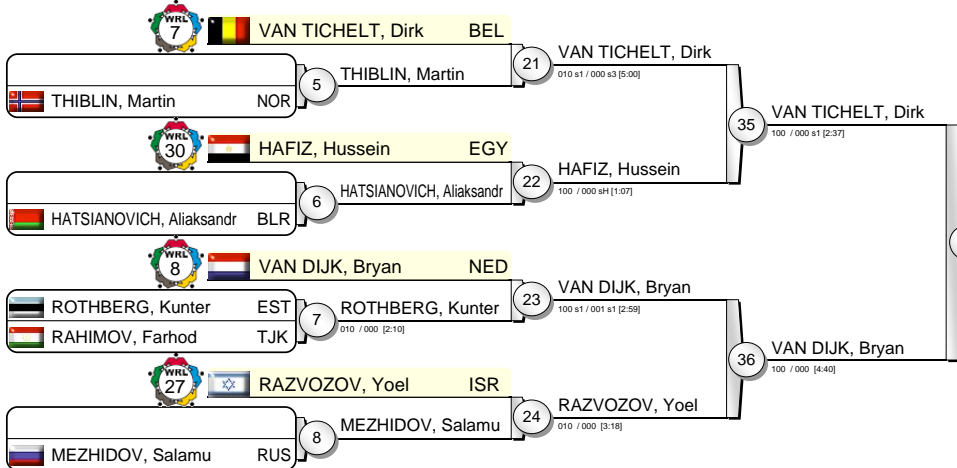

Pool C

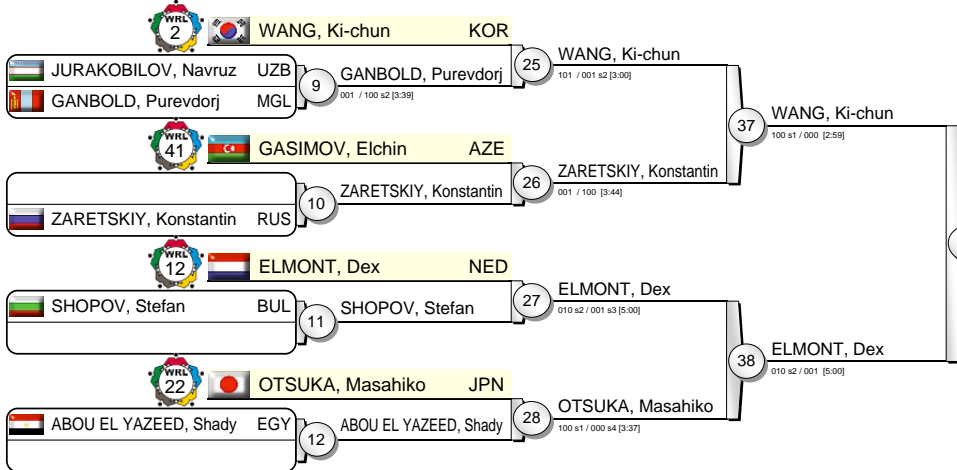

Pool D

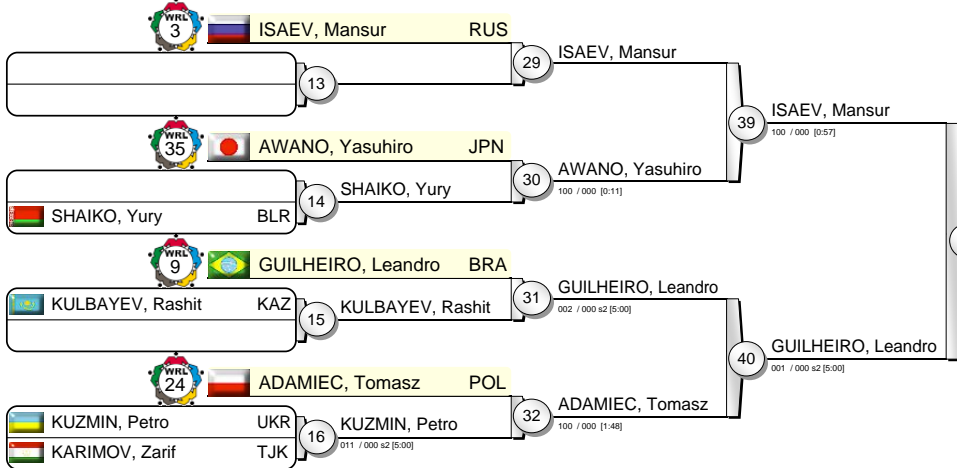

WANG, Ki-chun (47)

## Results

- |                       |     |
|-----------------------|-----|
| 1. WANG, Ki-chun      | KOR |
| 2. VAN TICHEL, Dirk   | BEL |
| 3. UNGVARI, Attila    | HUN |
| 3. ISAEV, Mansur      | RUS |
| 5. KAITMAZOV, Batradz | RUS |
| 5. VAN DIJK, Bryan    | NED |
| 5. ELMONT, Dex        | NED |
| 5. GUILHEIRO, Leandro | BRA |





# IJF Grand Slam Moscow 2009

(RUS Moscow, 30-31 May 2009)

# -81 kg

31 Judoka

Pool A

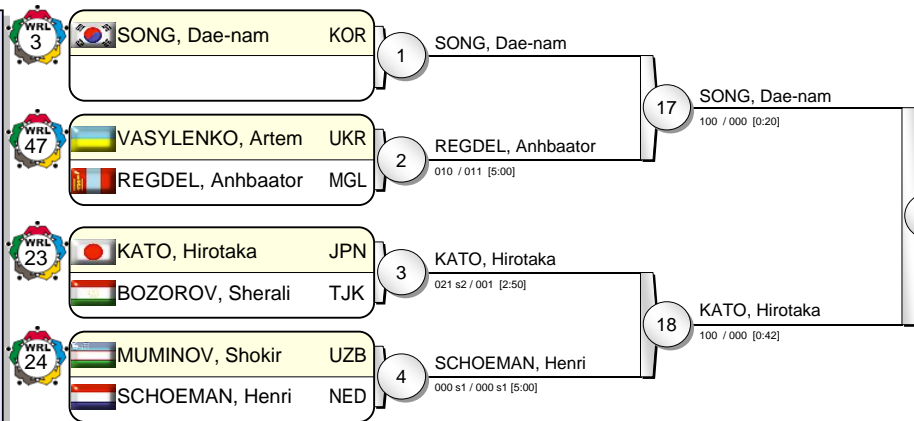

Pool B

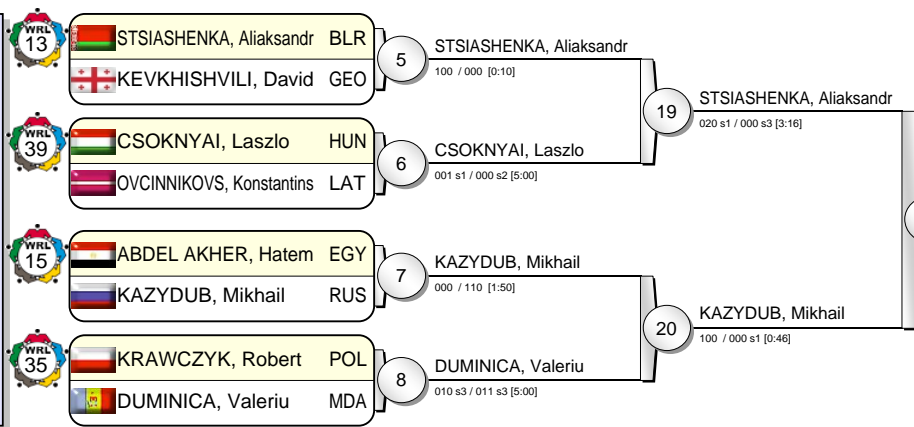

Pool C

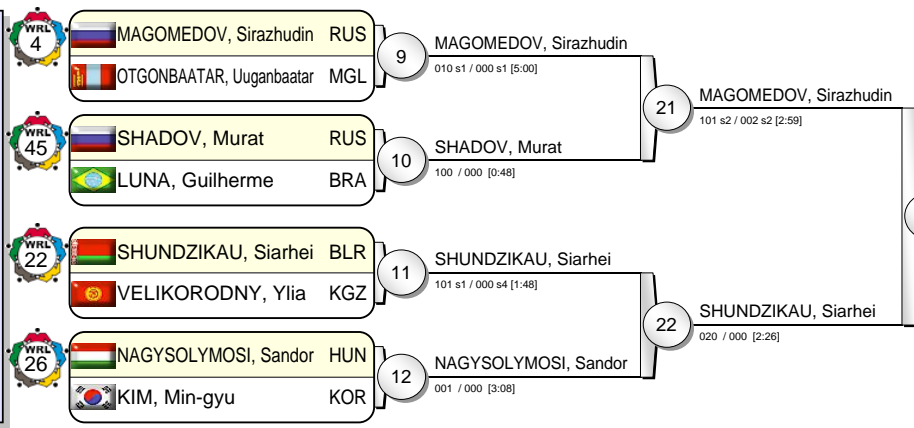

Pool D

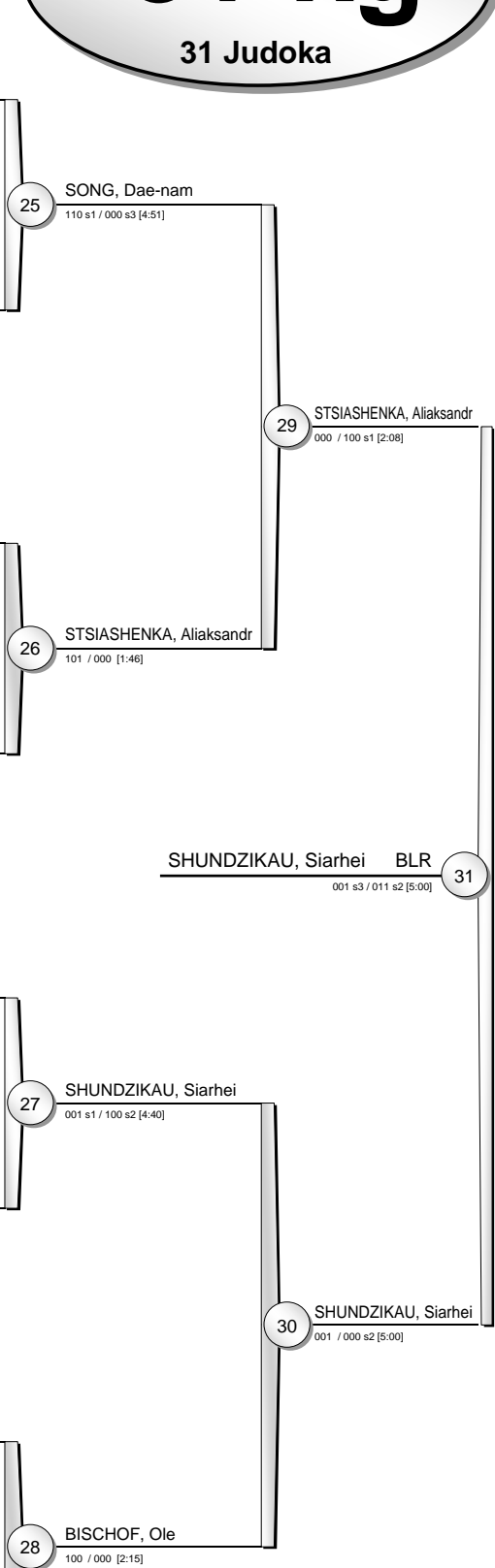
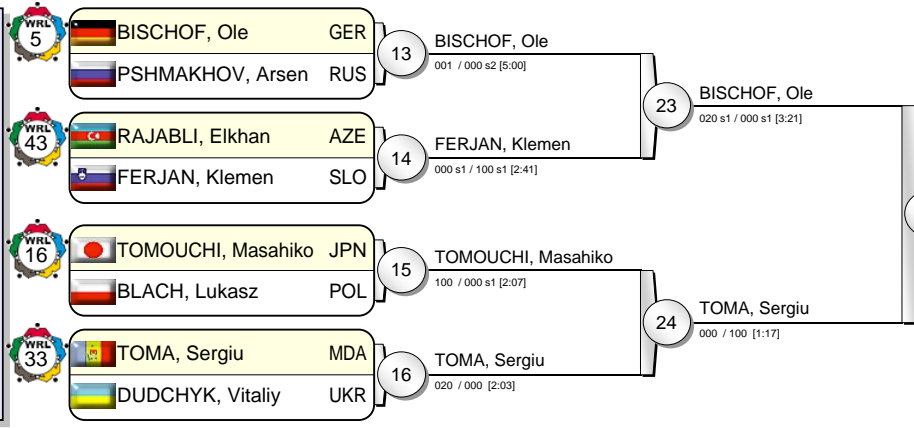

SHUNDZIKAU, Siarhei BLR 31  
001 s3 / 011 s2 [5:00]

## Results

- SHUNDZIKAU, Siarhei BLR
- STSIASHENKA, Aliaksandr BLR
- SONG, Dae-nam KOR
- BISCHOF, Ole GER
- KATO, Hirotaka JPN
- KAZYDUB, Mikhail RUS
- MAGOMEDOV, Sirazhudin RUS
- TOMA, Sergiu MDA





# IJF Grand Slam Moscow 2009

(RUS Moscow, 30-31 May 2009)

# -90 kg

26 Judoka

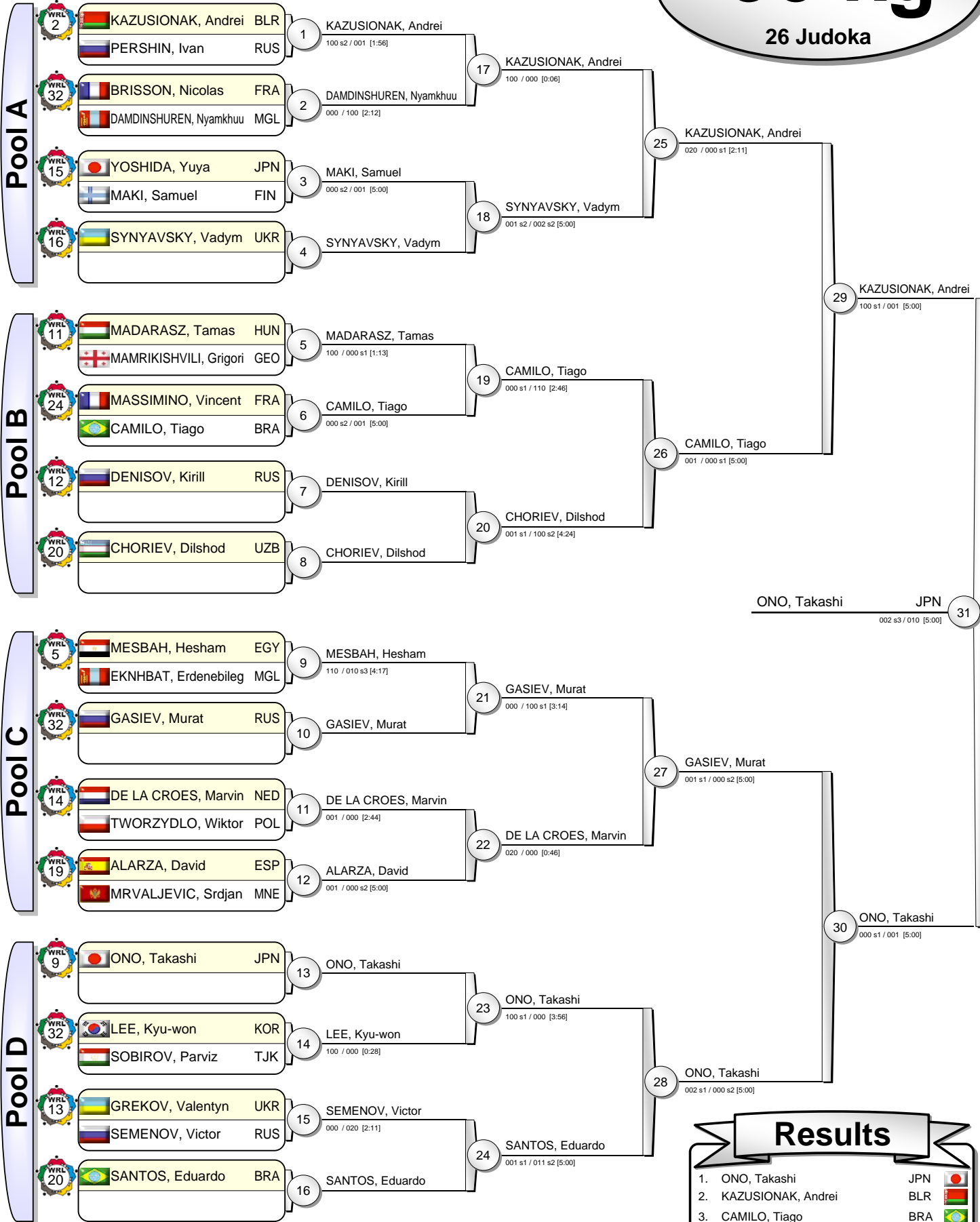

## Results

- |                        |     |  |
|------------------------|-----|--|
| 1. ONO, Takashi        | JPN |  |
| 2. KAZUSIONAK, Andrei  | BLR |  |
| 3. CAMILO, Tiago       | BRA |  |
| 3. GASIEV, Murat       | RUS |  |
| 5. SYNYAVSKY, Vadym    | UKR |  |
| 5. CHORIEV, Dilshod    | UZB |  |
| 5. DE LA CROES, Marvin | NED |  |
| 5. SANTOS, Eduardo     | BRA |  |





# IJF Grand Slam Moscow 2009

(RUS Moscow, 30-31 May 2009)

# -100 kg

24 Judoka

Pool A

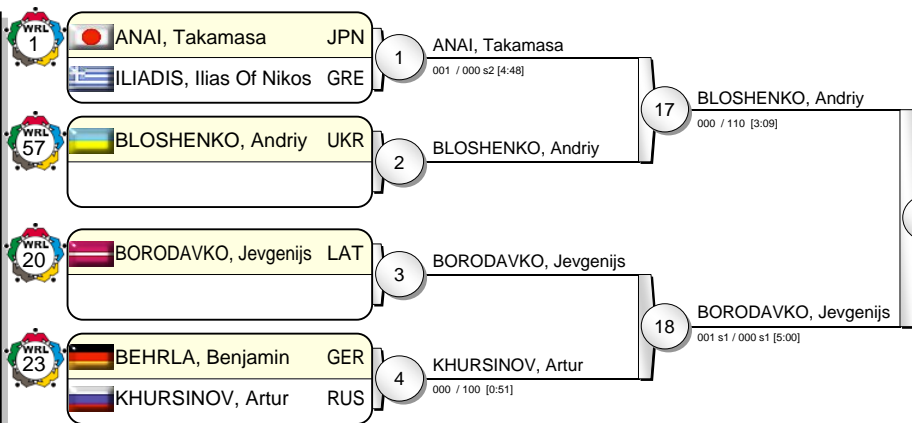

Pool B

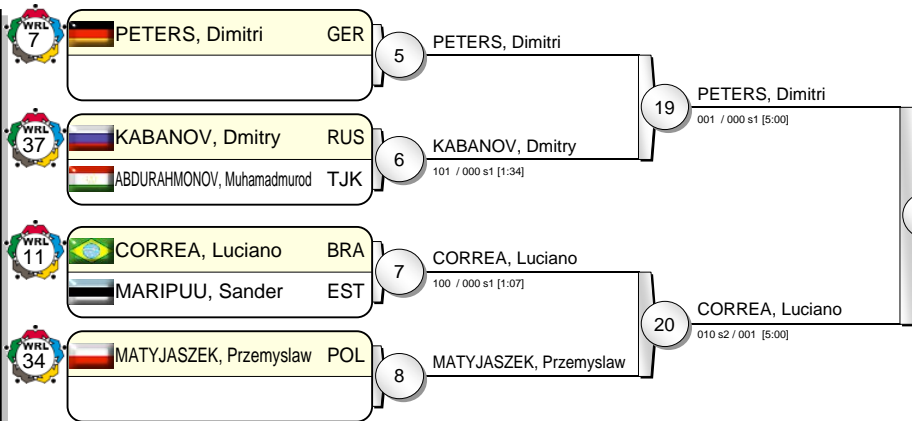

Pool C

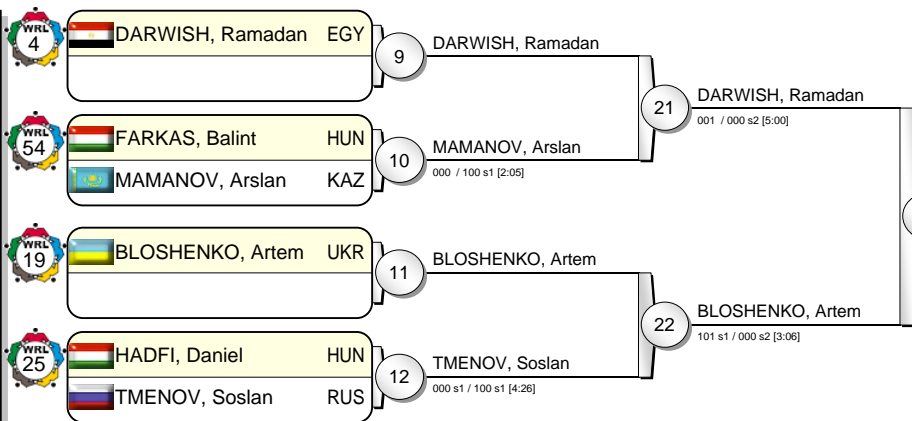

Pool D

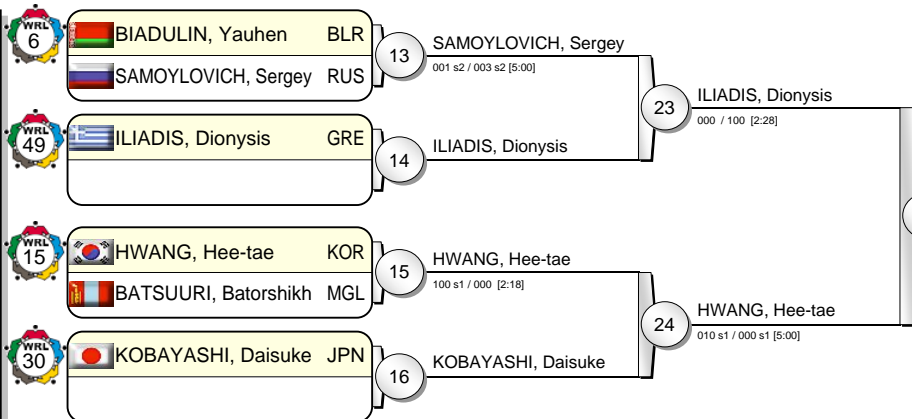

HWANG, Hee-tae KOR 31  
001 s1 / 010 s2 [5:00]

DARWISH, Ramadan EGY 27  
100 / 000 [0:20]

HWANG, Hee-tae KOR 30  
001 / 100 s1 [2:34]

HWANG, Hee-tae KOR 28  
000 / 101 [3:06]

## Results

- HWANG, Hee-tae KOR
- CORREA, Luciano BRA
- BORODAVKO, Jevgenijs LAT
- DARWISH, Ramadan EGY
- BLOSHENKO, Andriy UKR
- PETERS, Dimitri GER
- BLOSHENKO, Artem UKR
- ILIADIS, Dionysis GRE



www.r-r-g.ru



# IJF Grand Slam Moscow 2009

(RUS Moscow, 30-31 May 2009)

# +100 kg

20 Judoka

Pool A

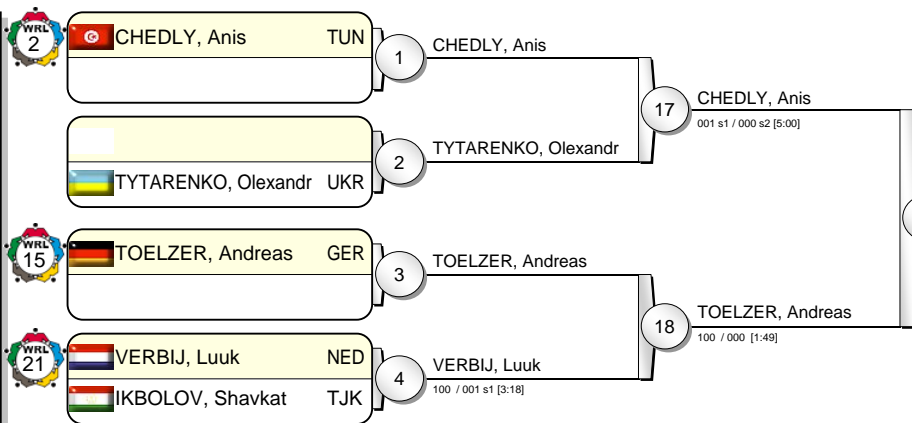

Pool B

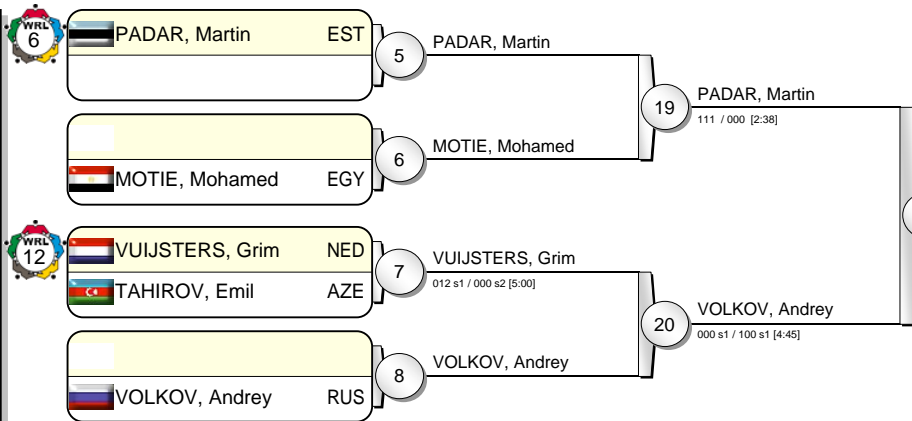

Pool C

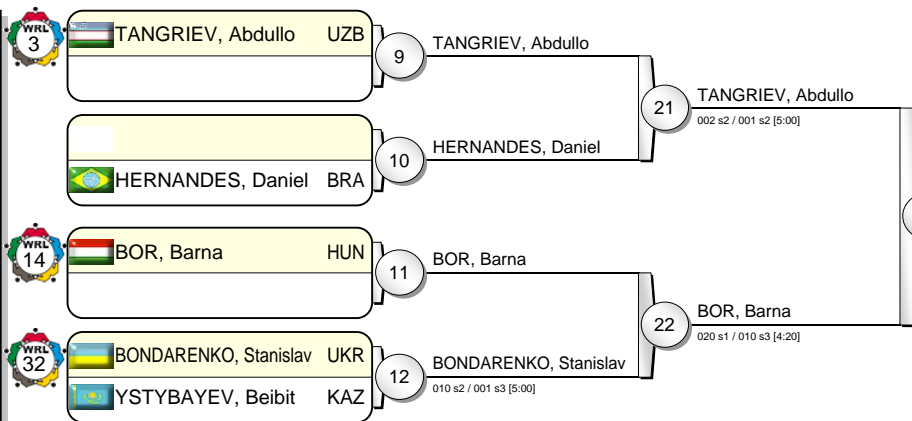

Pool D

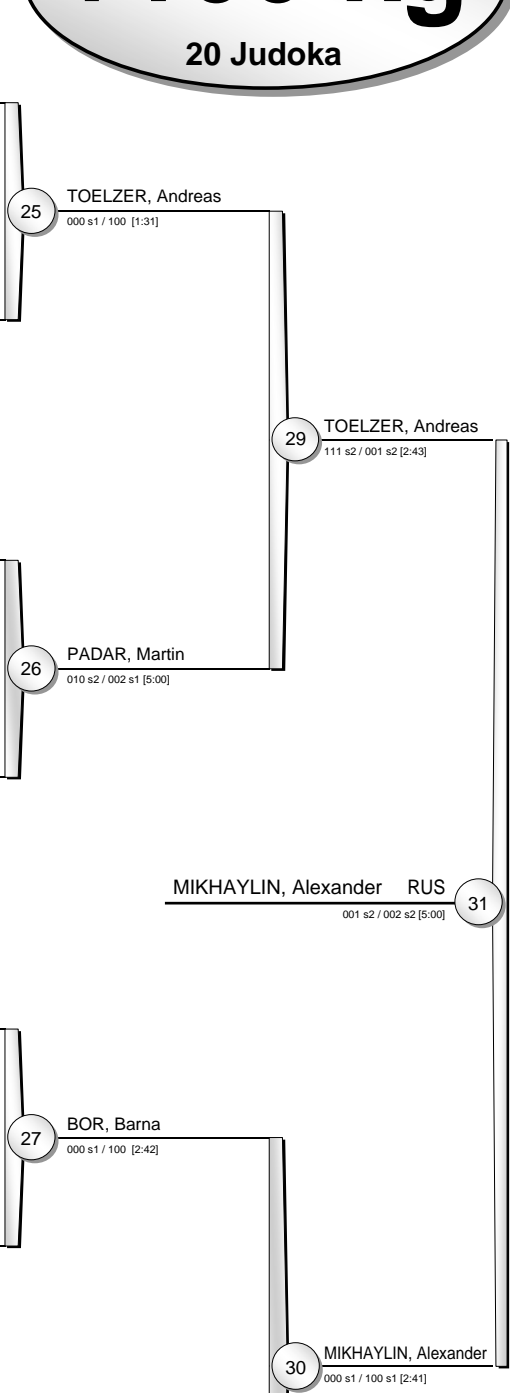
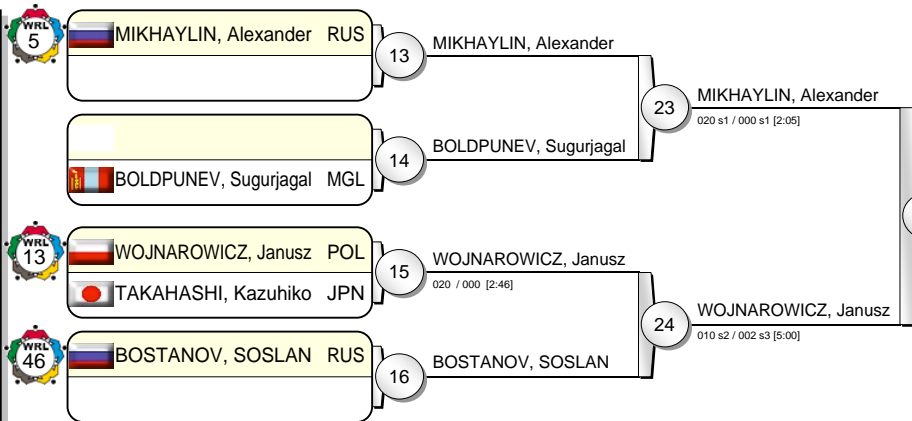

MIKHAYLIN, Alexander RUS 31 (001 s2 / 002 s2 [5:00])

## Results

- MIKHAYLIN, Alexander RUS
- TOELZER, Andreas GER
- PADAR, Martin EST
- BOR, Barna HUN
- CHEDLY, Anis TUN
- VOLKOV, Andrey RUS
- TANGRIEV, Abdullo UZB
- WOJNAROWICZ, Janusz POL





# IJF Grand Slam Moscow 2009

(RUS Moscow, 30-31 May 2009)

# -48 kg

17 Judoka

Pool A

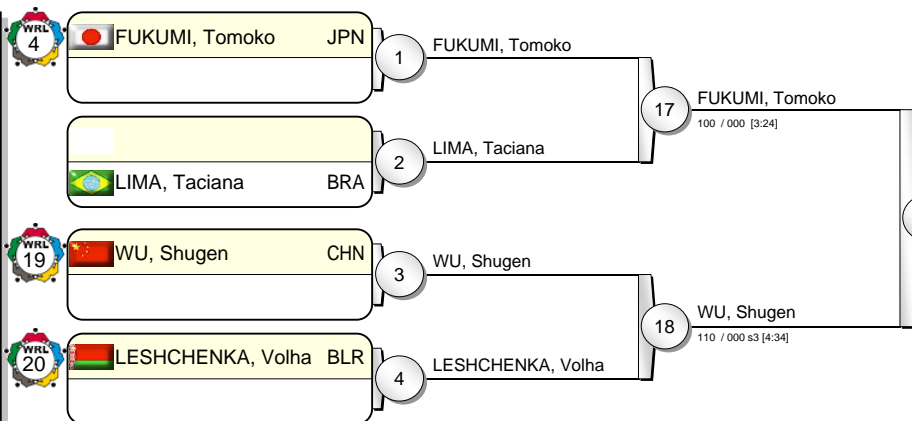

Pool B

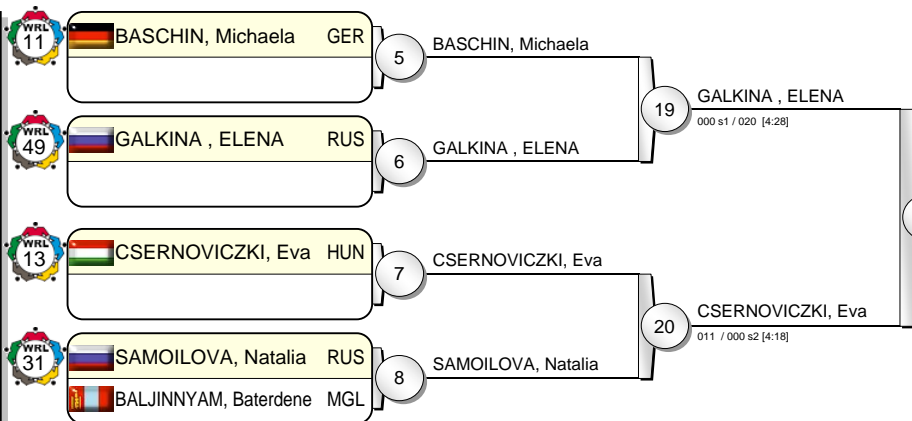

Pool C

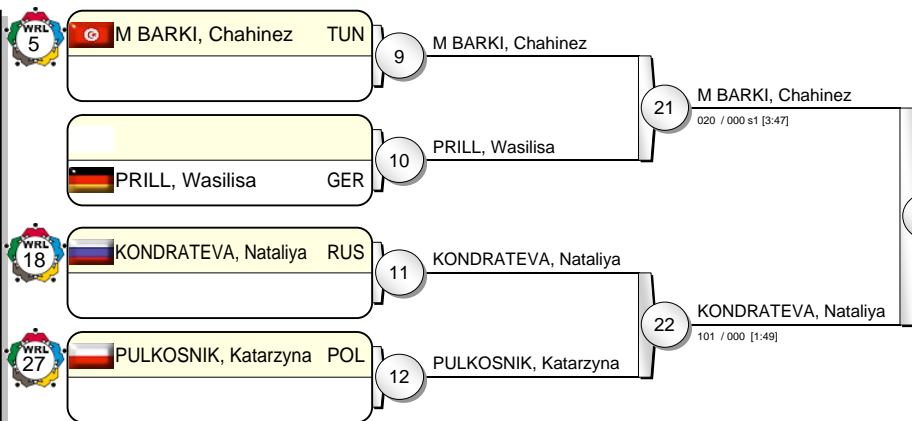

Pool D

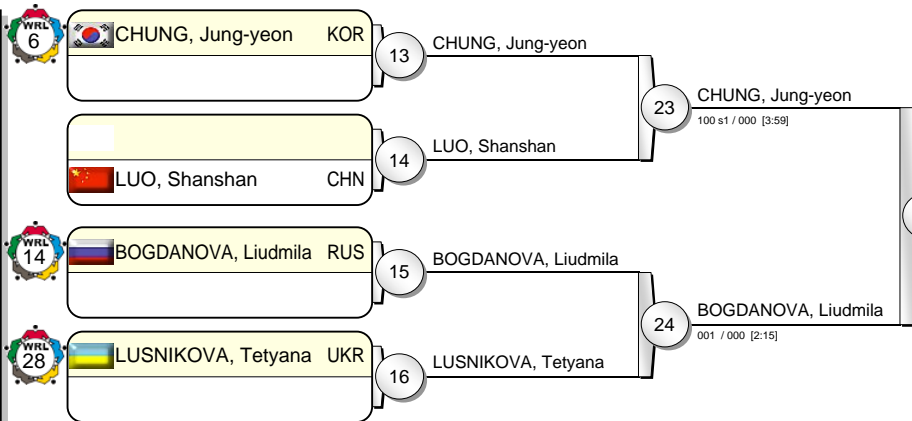

FUKUMI, Tomoko JPN 31  
100 / 000 [0:45]

CHUNG, Jung-yeon 30  
000 s2 / 001 s1 [5:00]

## Results

- |                         |     |  |
|-------------------------|-----|--|
| 1. FUKUMI, Tomoko       | JPN |  |
| 2. CHUNG, Jung-yeon     | KOR |  |
| 3. CSERNOVICZKI, Eva    | HUN |  |
| 3. M BARKI, Chahinez    | TUN |  |
| 5. WU, Shugen           | CHN |  |
| 5. GALKINA, ELENA       | RUS |  |
| 5. KONDRATEVA, Nataliya | RUS |  |
| 5. BOGDANOVA, Liudmila  | RUS |  |



www.i-jf.ru



# IJF Grand Slam Moscow 2009

(RUS Moscow, 30-31 May 2009)

# -52 kg

21 Judoka

Pool A

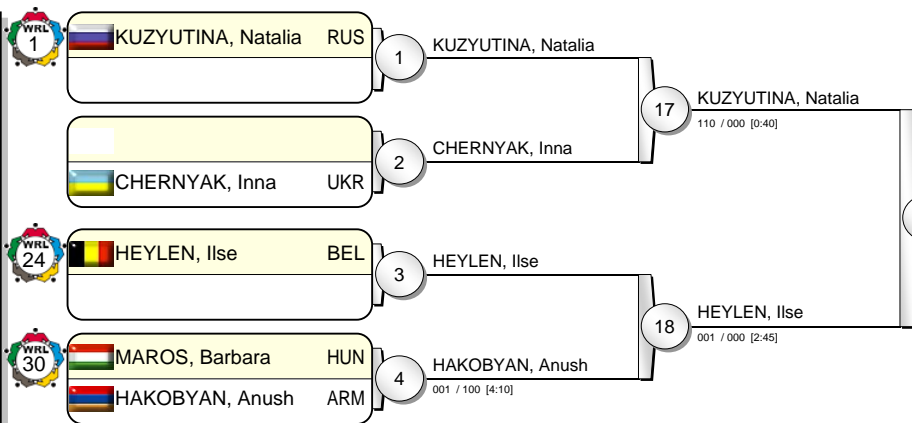

Pool B

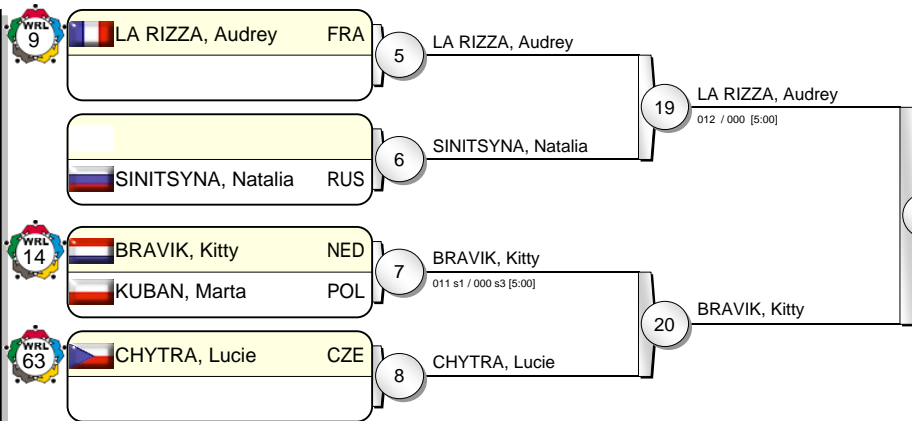

Pool C

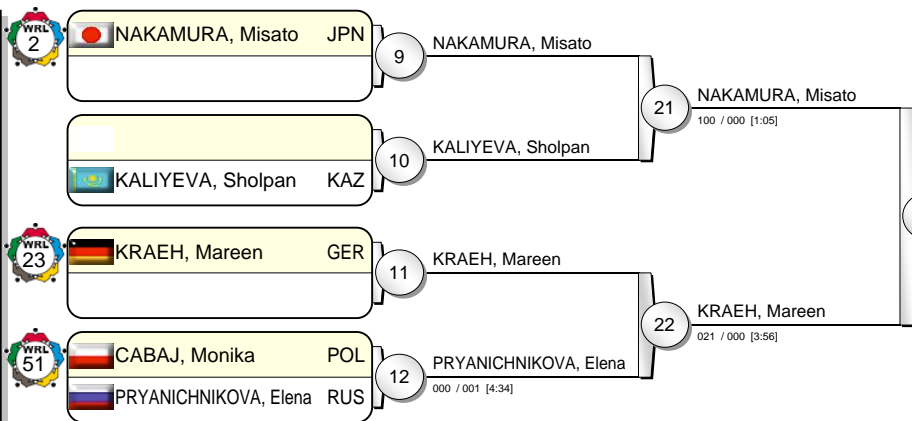

Pool D

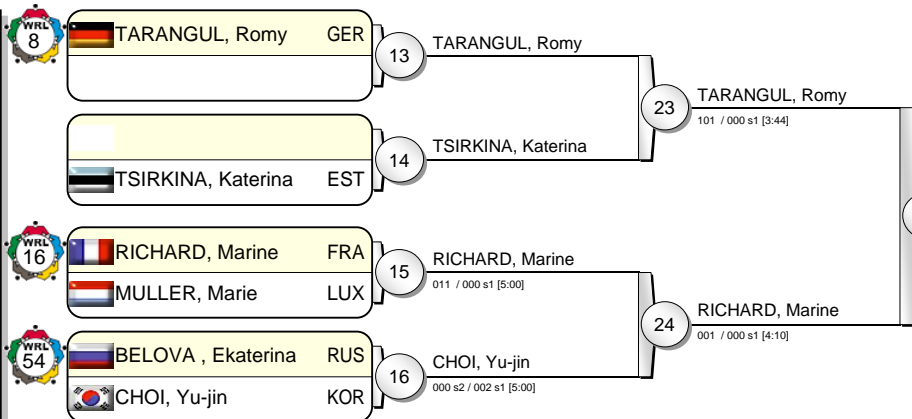

NAKAMURA, Misato JPN  
000 s2 / 001 s1 [5:00] 31

29 KUZUYUTINA, Natalia  
001 / 000 s2 [5:00]

25 KUZUYUTINA, Natalia  
000 / 000 s1 [5:00]

26 BRAVIK, Kitty  
000 s1 / 000 s1 [5:00]

27 NAKAMURA, Misato  
021 / 000 s1 [4:57]

28 TARANGUL, Romy  
100 / 000 s1 [2:16]

## Results

- |                        |     |  |
|------------------------|-----|--|
| 1. NAKAMURA, Misato    | JPN |  |
| 2. KUZUYUTINA, Natalia | RUS |  |
| 3. BRAVIK, Kitty       | NED |  |
| 3. TARANGUL, Romy      | GER |  |
| 5. HEYLEN, Ilse        | BEL |  |
| 5. LA RIZZA, Audrey    | FRA |  |
| 5. KRAEH, Mareen       | GER |  |
| 5. RICHARD, Marine     | FRA |  |





# IJF Grand Slam Moscow 2009

(RUS Moscow, 30-31 May 2009)

# -57 kg

23 Judoka

Pool A

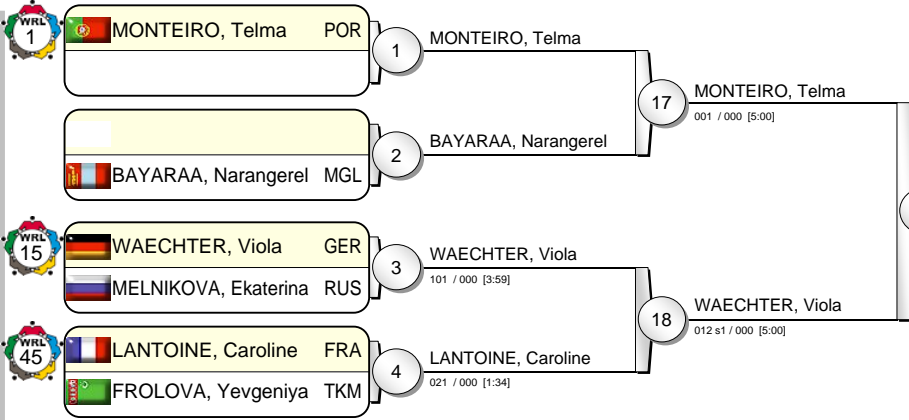

Pool B

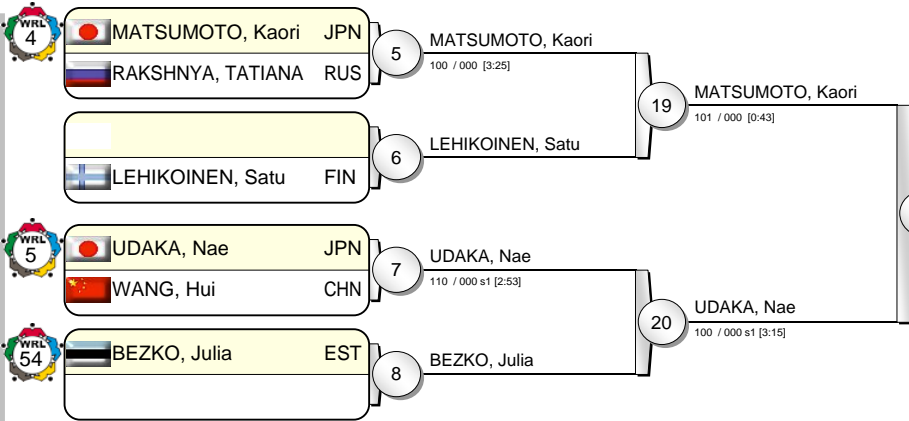

Pool C

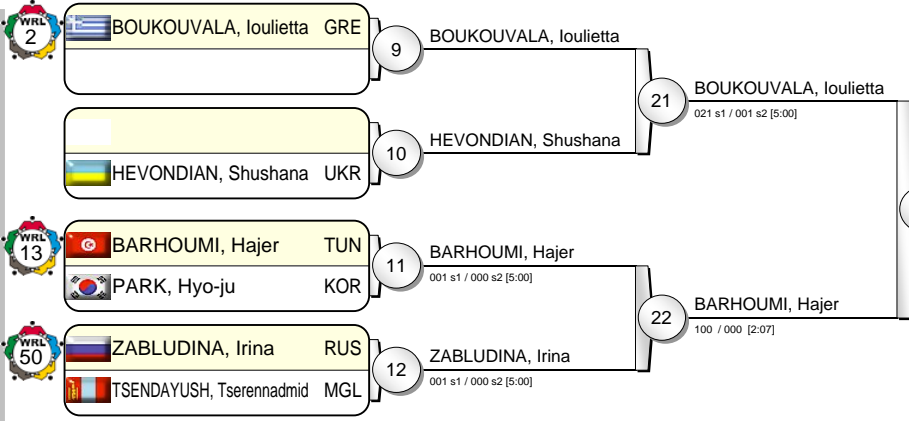

Pool D

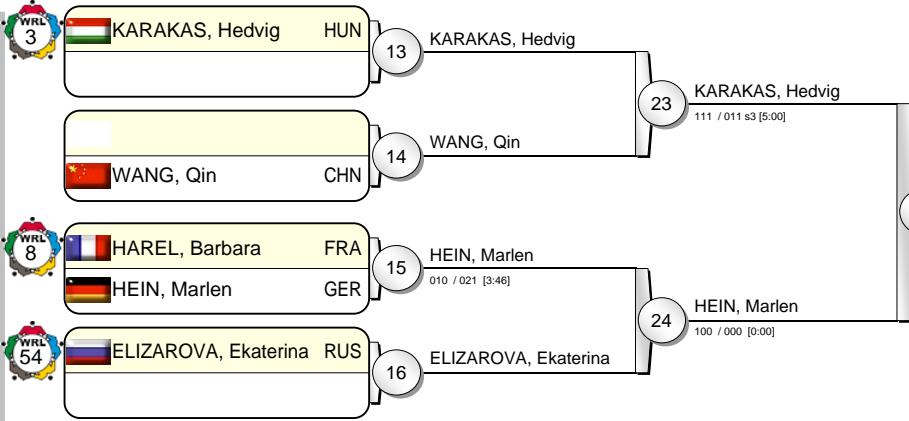

MATSUMOTO, Kaori (JPN) 31

## Results

- MATSUMOTO, Kaori (JPN)
- KARAKAS, Hedvig (HUN)
- MONTEIRO, Telma (POR)
- BOUKOUVALA, Ioulietta (GRE)
- WAECHTER, Viola (GER)
- UDAKA, Nae (JPN)
- BARHOUMI, Hajer (TUN)
- HEIN, Marlen (GER)





# IJF Grand Slam Moscow 2009

(RUS Moscow, 30-31 May 2009)

# -63 kg

20 Judoka

Pool A

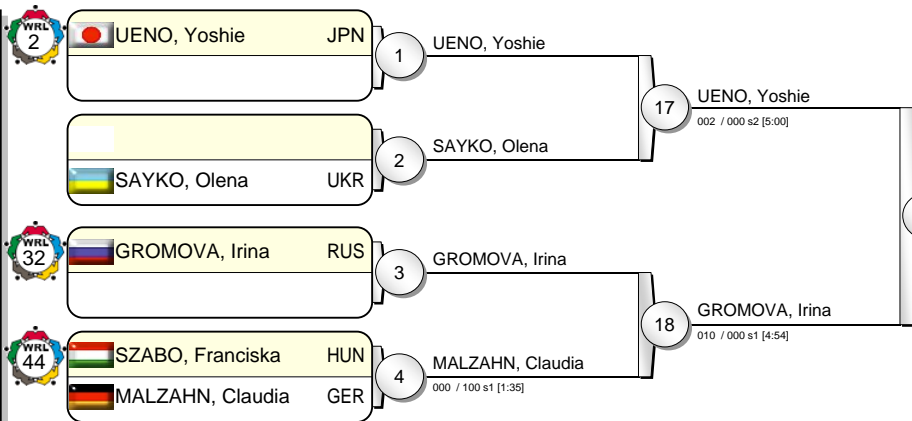

Pool B

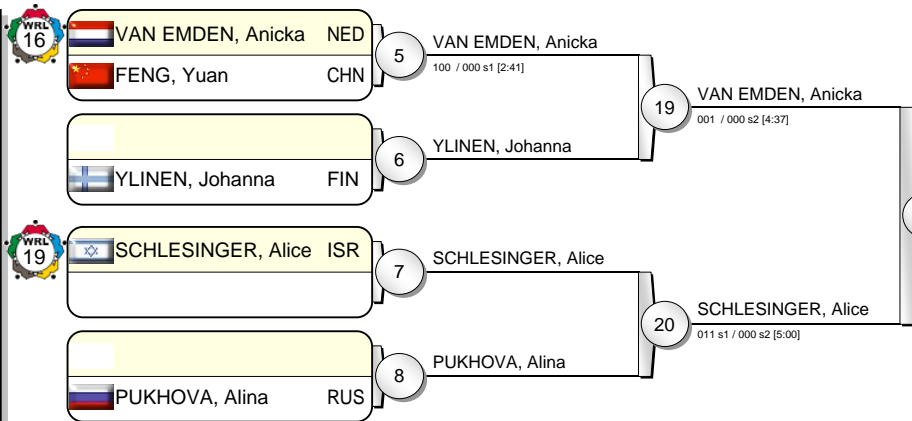

Pool C

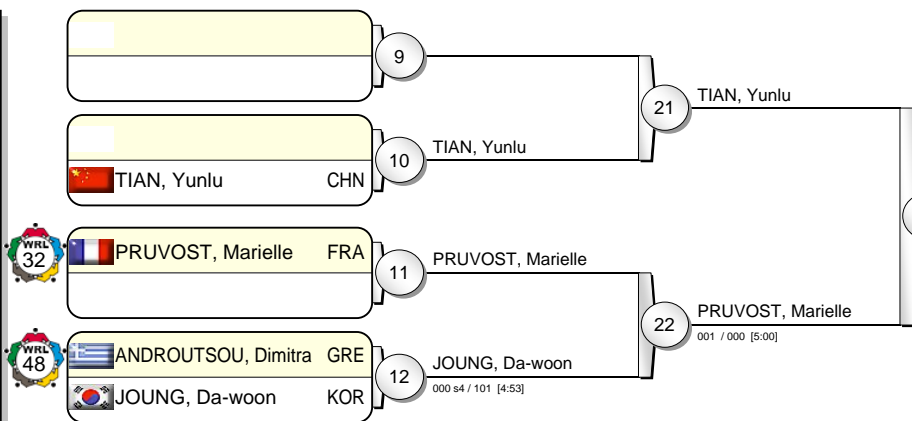

Pool D

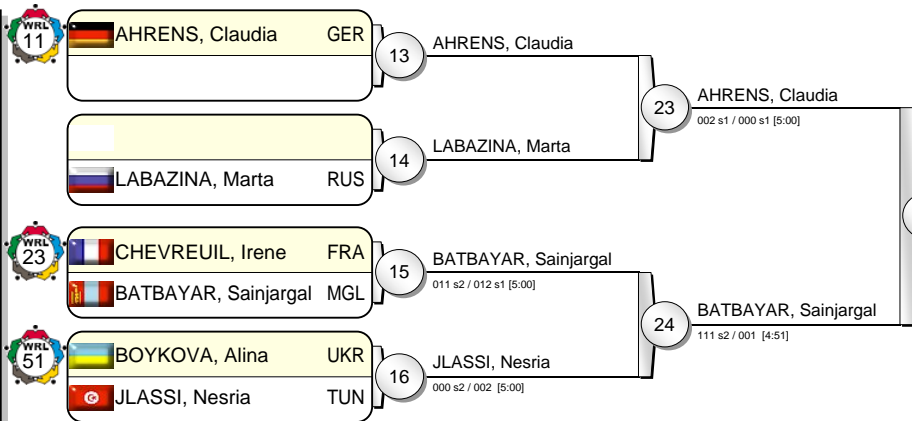

PRUVOST, Marielle FRA 31  
000 s1 / 001 s1 [5:00]

PRUVOST, Marielle 30  
100 / 000 [0:12]

## Results

- PRUVOST, Marielle FRA
- UENO, Yoshie JPN
- VAN EMDEN, Anicka NED
- BATBAYAR, Sainjargal MGL
- GROMOVA, Irina RUS
- SCHLESINGER, Alice ISR
- TIAN, Yunlu CHN
- AHRENS, Claudia GER





# IJF Grand Slam Moscow 2009

(RUS Moscow, 30-31 May 2009)

# -70 kg

22 Judoka

Pool A

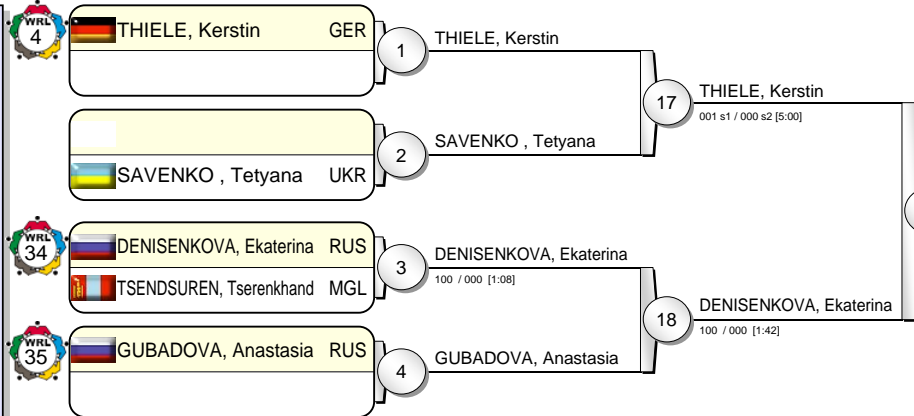

Pool B

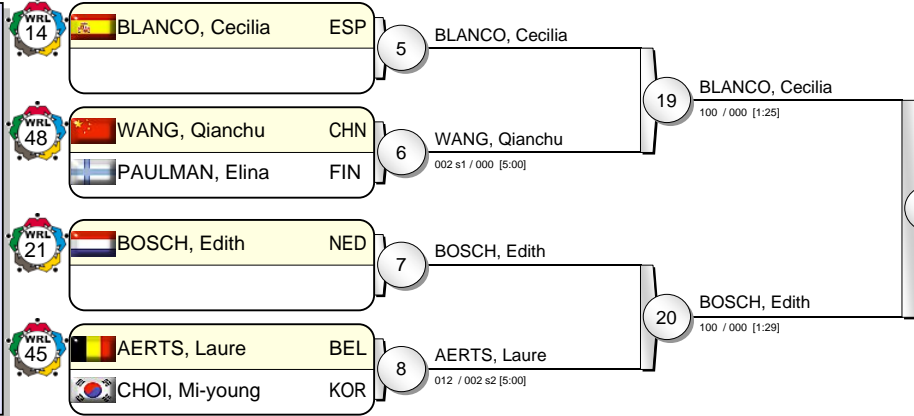

Pool C

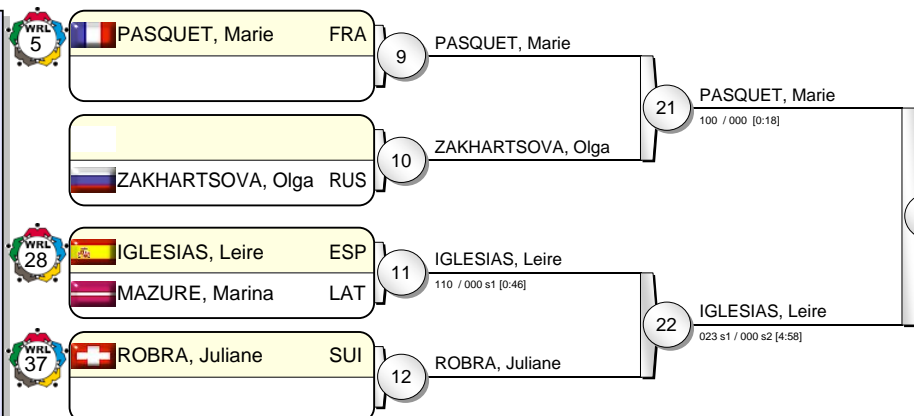

Pool D

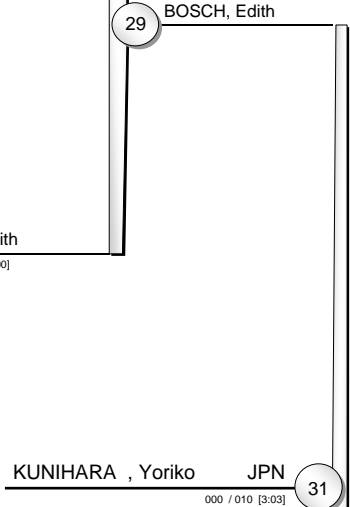
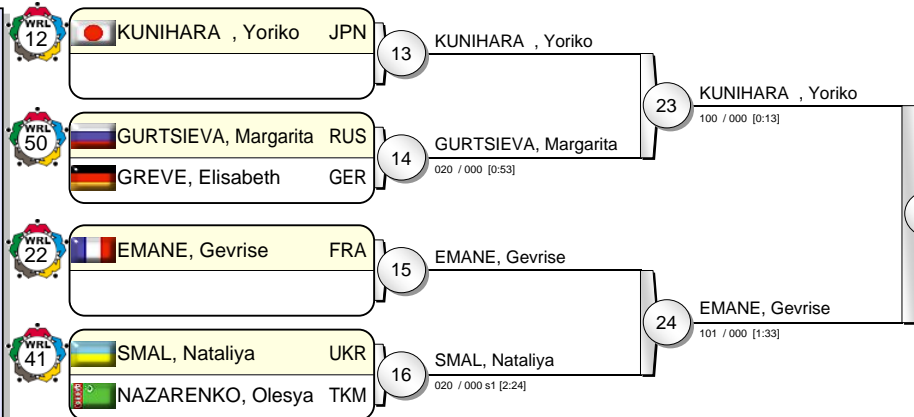

## Results

- KUNIHARA, Yoriko JPN
- BOSCH, Edith NED
- THIELE, Kerstin GER
- PASQUET, Marie FRA
- DENISENKOVA, Ekaterina RUS
- BLANCO, Cecilia ESP
- IGLESIAS, Leire ESP
- EMANE, Gevrise FRA





# IJF Grand Slam Moscow 2009

(RUS Moscow, 30-31 May 2009)

# -78 kg

18 Judoka

Pool A

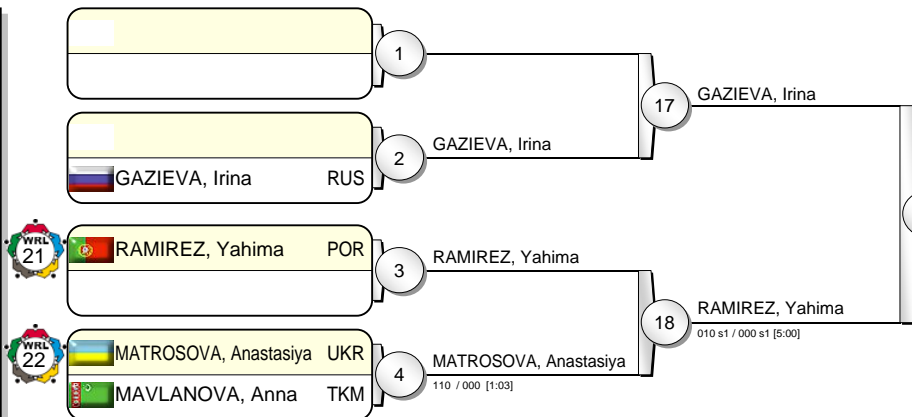

Pool B

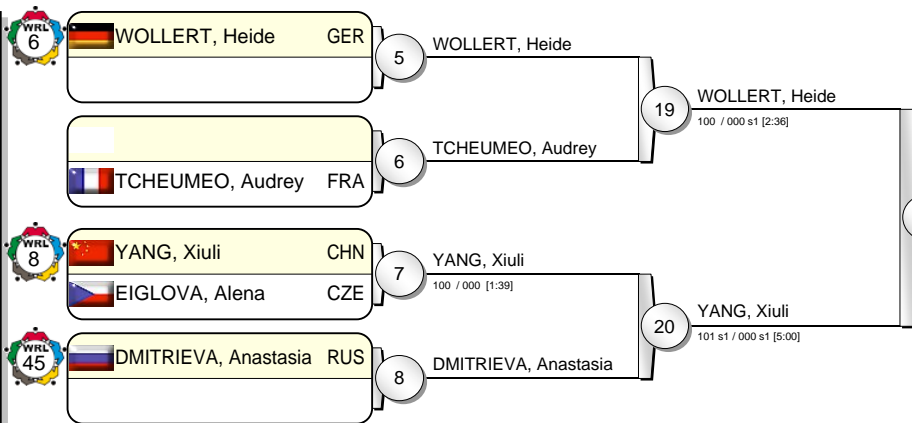

Pool C

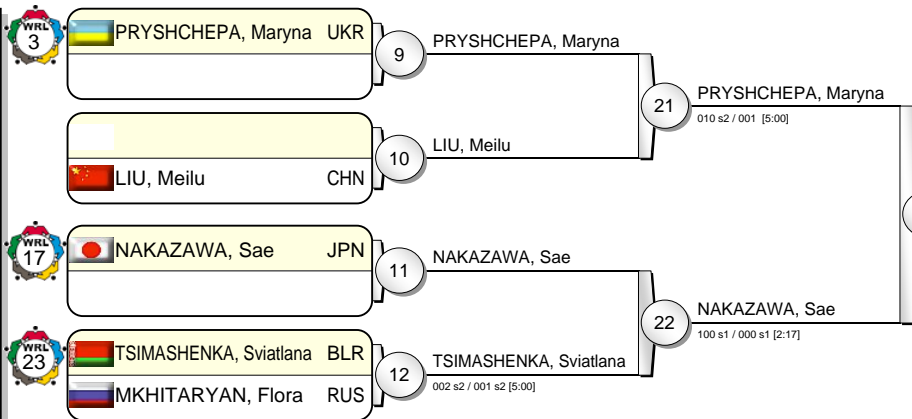

Pool D

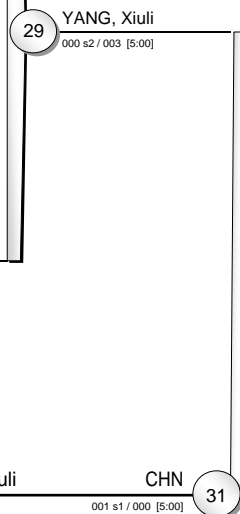
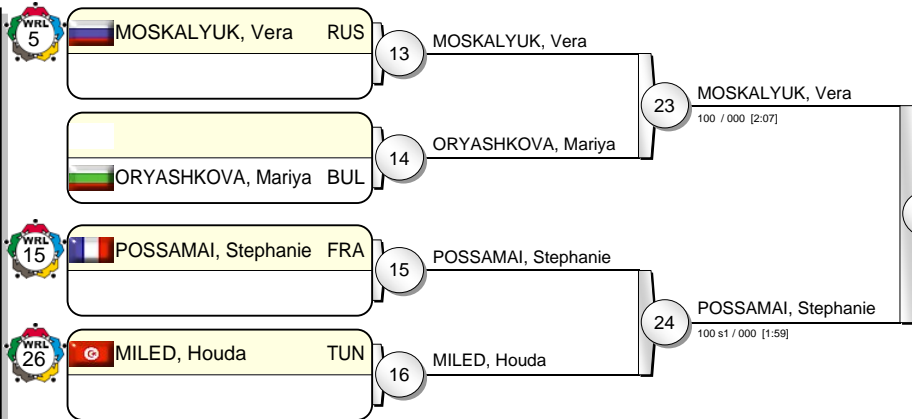

YANG, Xiuli CHN 31  
001 s1 / 000 [5:00]

## Results

1. YANG, Xiuli CHN
2. POSSAMAI, Stephanie FRA
3. RAMIREZ, Yahima POR
3. PRYSHCHEPA, Maryna UKR
5. GAZIEVA, Irina RUS
5. WOLLERT, Heide GER
5. NAKAZAWA, Sae JPN
5. MOSKALYUK, Vera RUS



www.r-r-g.ru



# IJF Grand Slam Moscow 2009

(RUS Moscow, 30-31 May 2009)

# +78 kg

13 Judoka

Pool A

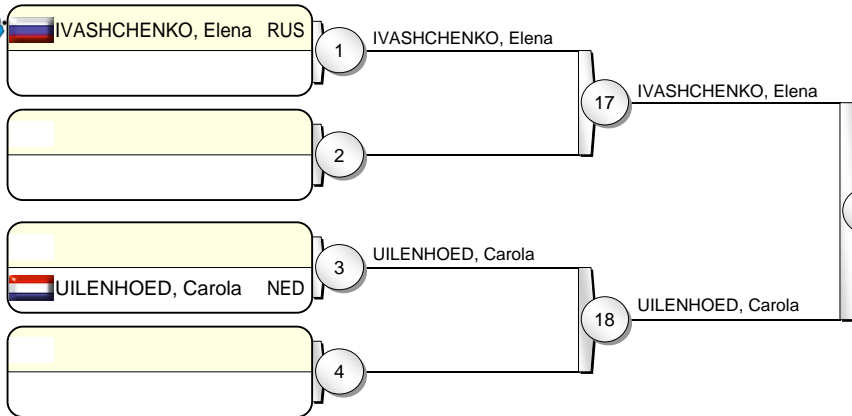

Pool B

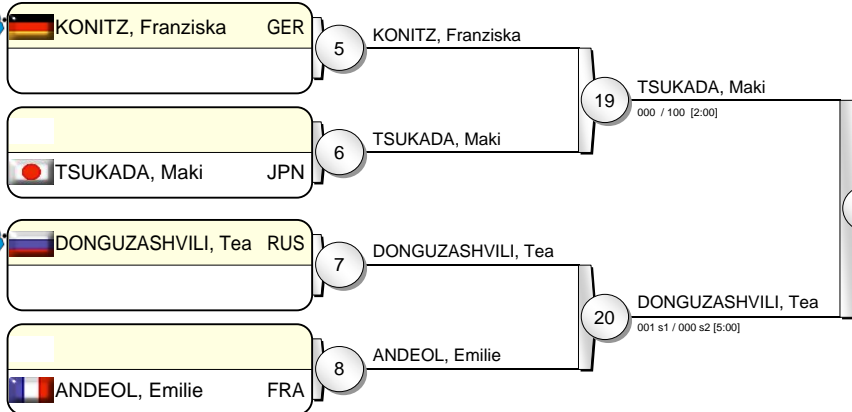

Pool C

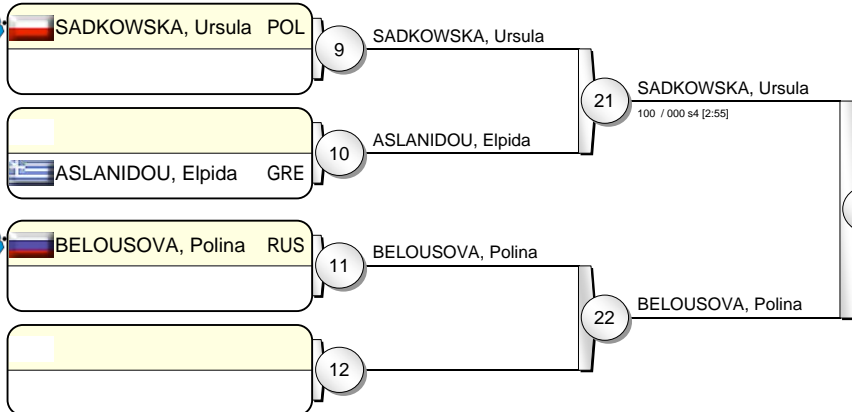

Pool D

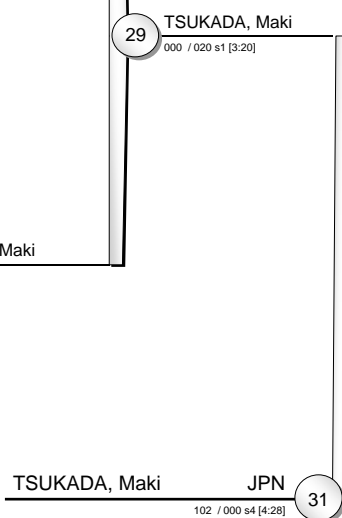
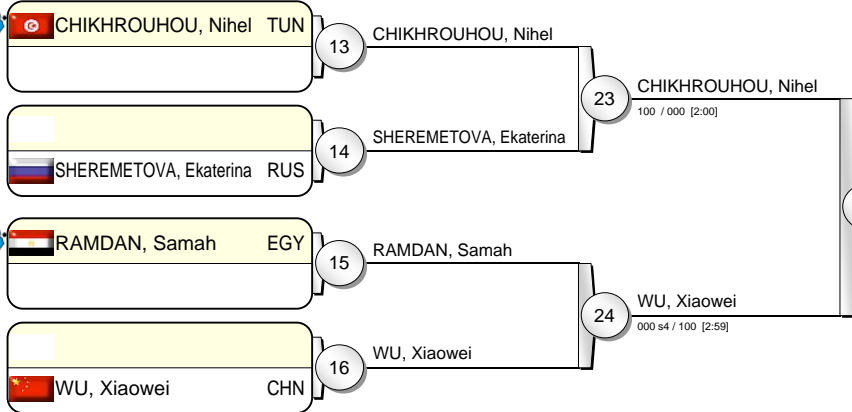

TSUKADA, Maki JPN 31  
102 / 000 s4 [4:26]

## Results

- |                       |     |  |
|-----------------------|-----|--|
| 1. TSUKADA, Maki      | JPN |  |
| 2. CHIKHROUHO, Nihel  | TUN |  |
| 3. IVASHCHENKO, Elena | RUS |  |
| 3. SADKOWSKA, Ursula  | POL |  |
| 5. UILENHOED, Carola  | NED |  |
| 5. DONGUZASHVILI, Tea | RUS |  |
| 5. BELOUSOVA, Polina  | RUS |  |
| 5. WU, Xiaowei        | CHN |  |

