



# IJF Grand Prix Tunis 2010

(TUN Tunis, 07-09 May 2010)

# -60 kg

28 Judoka

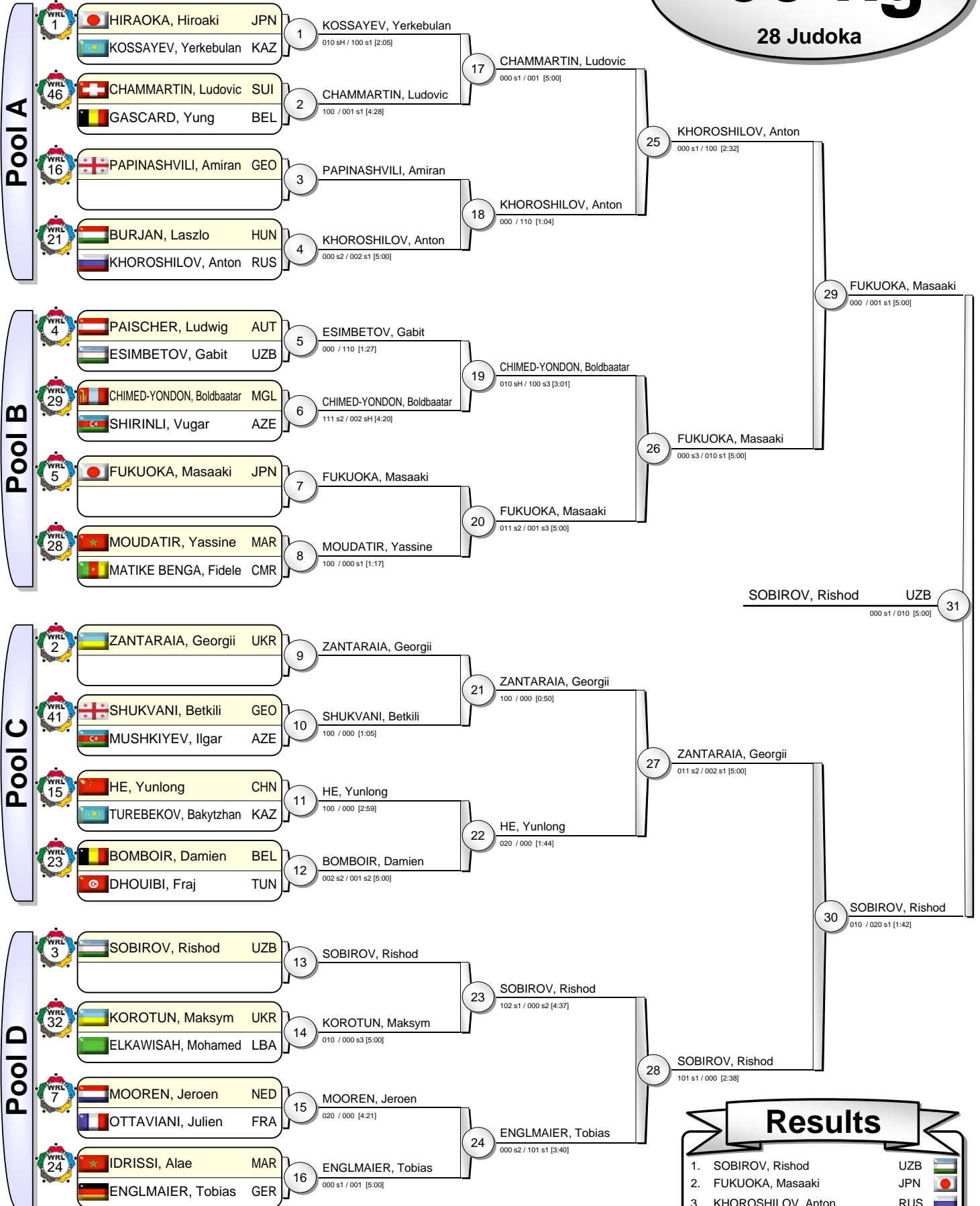

## Results

- |                              |     |  |
|------------------------------|-----|--|
| 1. SOBIROV, Rishod           | UZB |  |
| 2. FUKUOKA, Masaaki          | JPN |  |
| 3. KHOROSHILOV, Anton        | RUS |  |
| 3. ZANTARAIA, Georgii        | UKR |  |
| 5. CHAMMARTIN, Ludovic       | SUI |  |
| 5. CHIMED-YONDON, Boldbaatar | MGL |  |
| 5. HE, Yunlong               | CHN |  |
| 5. ENGLMAIER, Tobias         | GER |  |





# IJF Grand Prix Tunis 2010

(TUN Tunis, 07-09 May 2010)

# -66 kg

35 Judoka

Pool A

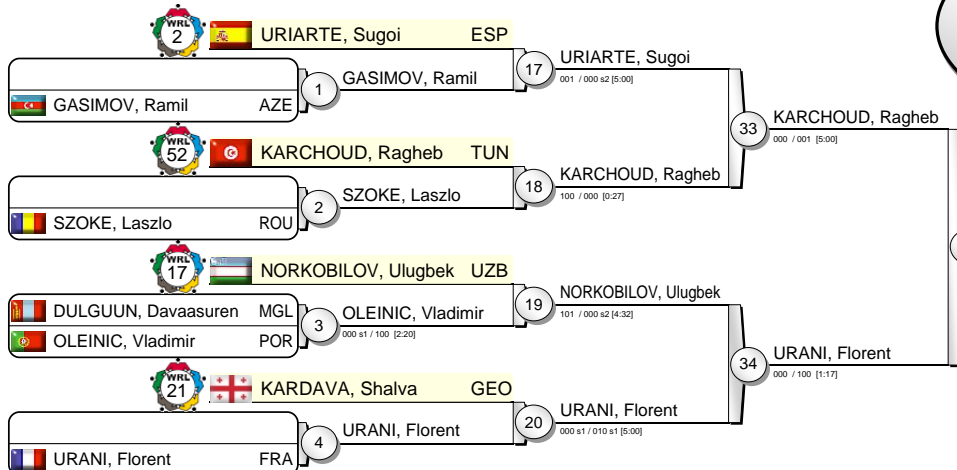

Pool B

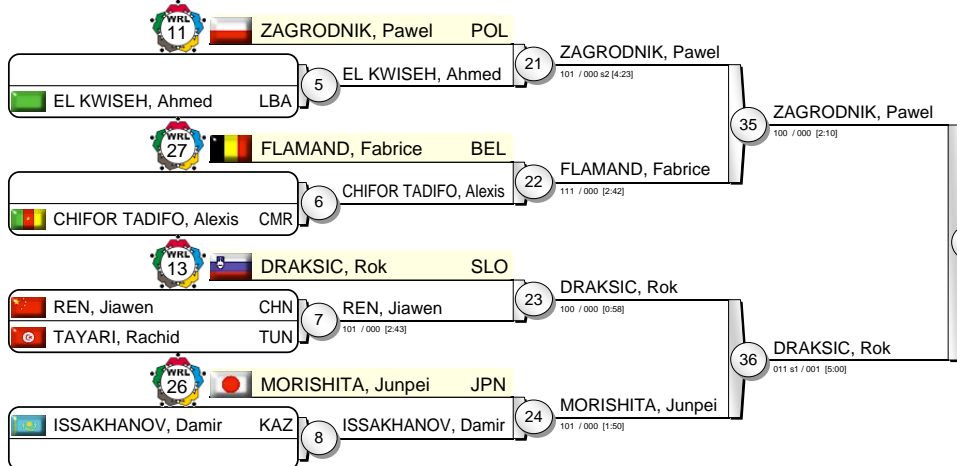

Pool C

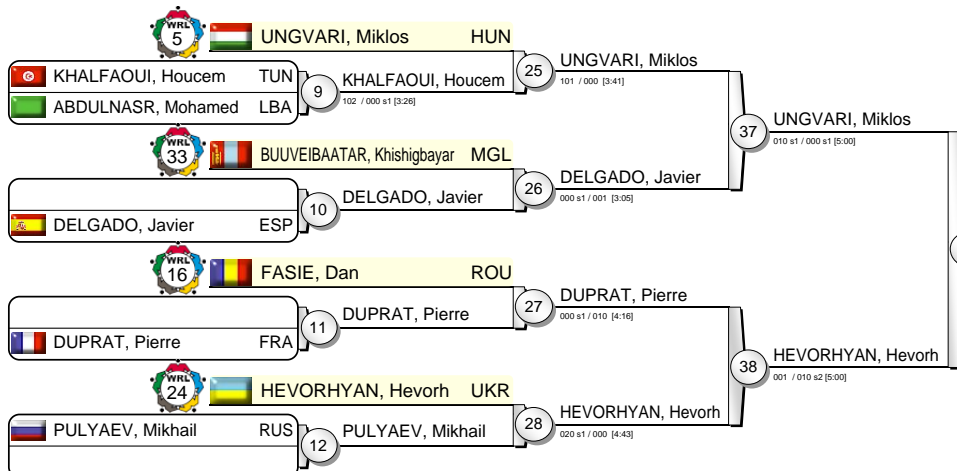

Pool D

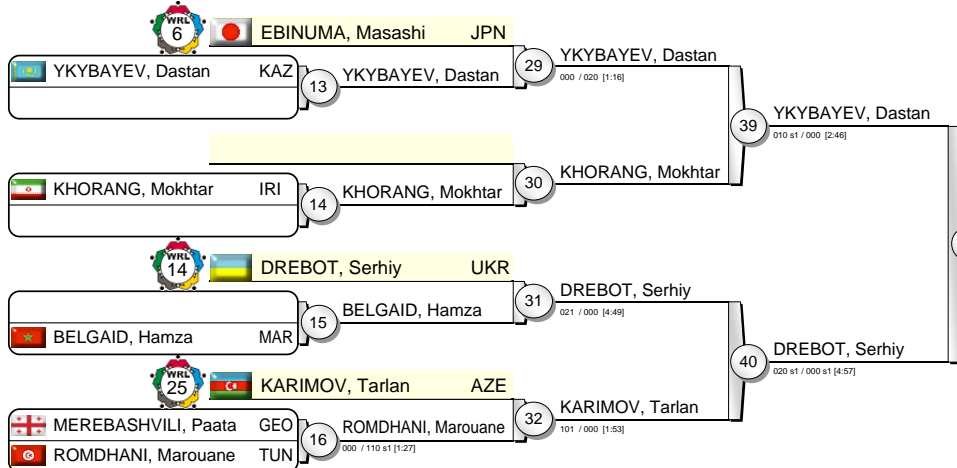

DRAKSIC, Rok

100 / 011 s1 [4:50]

47

43

UNGVARI, Miklos

002 s1 / 000 s2 [5:00]

46

UNGVARI, Miklos

101 / 000 s1 [3:18]

## Results

1. DRAKSIC, Rok SLO
2. UNGVARI, Miklos HUN
3. URANI, Florent FRA
3. YKYBAYEV, Dastan KAZ
5. KARCHOUD, Ragheb TUN
5. ZAGRODNIK, Pawel POL
5. HEVORHYAN, Hevorh UKR
5. DREBOT, Serhiy UKR





# IJF Grand Prix Tunis 2010

(TUN Tunis, 07-09 May 2010)

# -73 kg

42 Judoka

Pool A

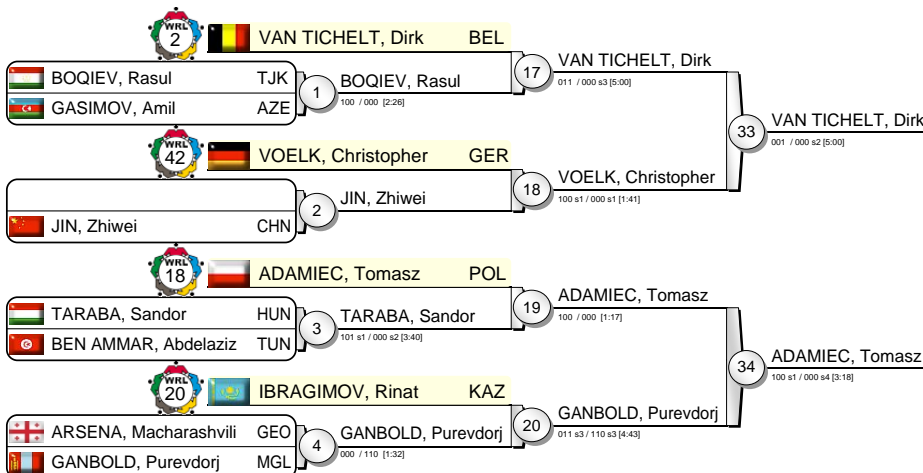

Pool B

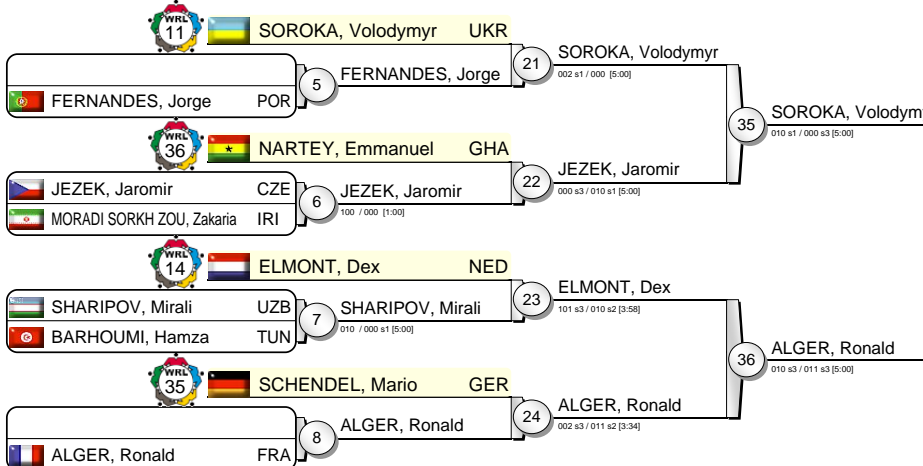

Pool C

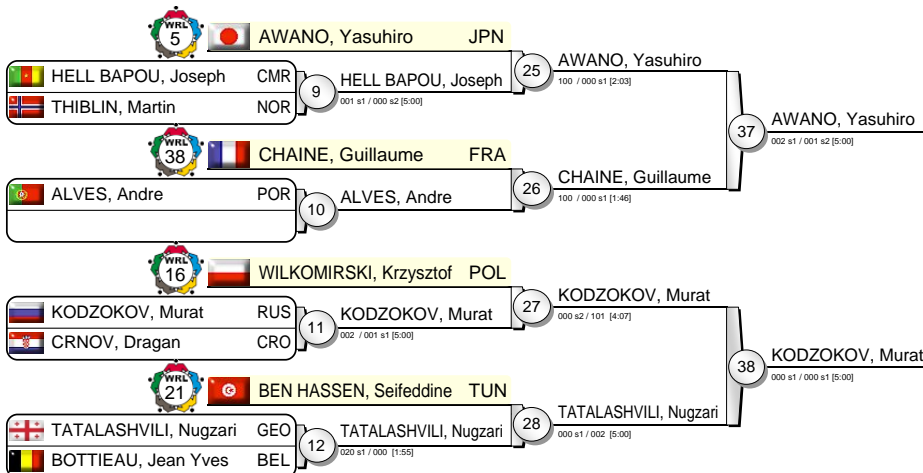

Pool D

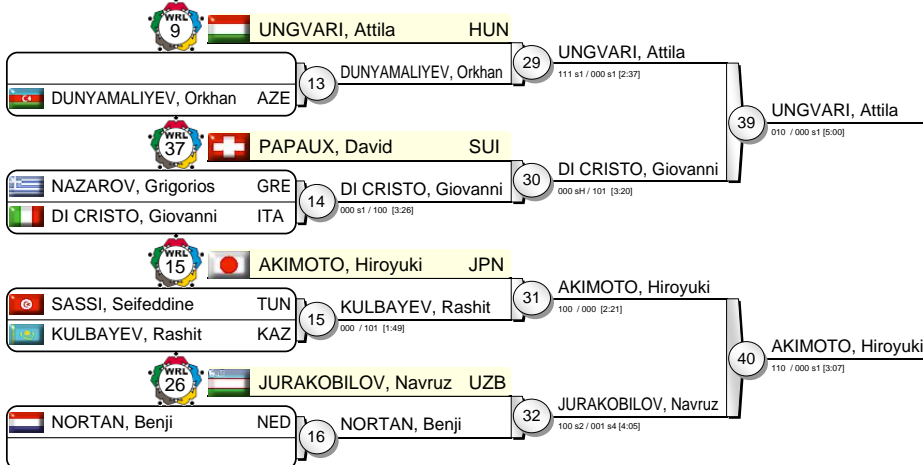

SOROKA, Volodymyr

100 / 001 [1:52]

## Results

- SOROKA, Volodymyr (UKR)
- AKIMOTO, Hiroyuki (JPN)
- VAN TICHELT, Dirk (BEL)
- KODZOKOV, Murat (RUS)
- ADAMIEC, Tomasz (POL)
- ALGER, Ronald (FRA)
- AWANO, Yasuhiro (JPN)
- UNGVARI, Attila (HUN)







# IJF Grand Prix Tunis 2010

(TUN Tunis, 07-09 May 2010)

# -90 kg

31 Judoka

Pool A

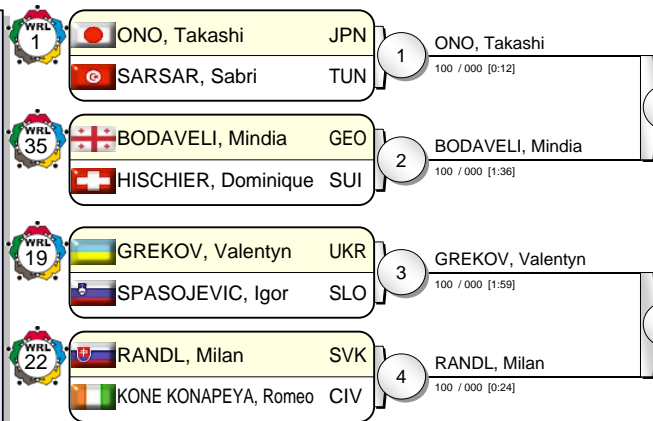

Pool B

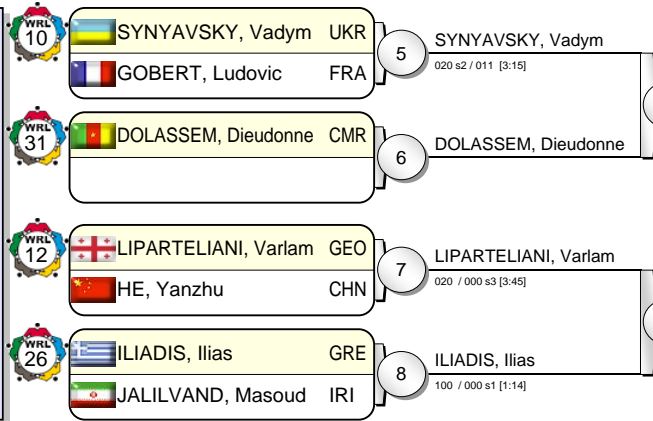

Pool C

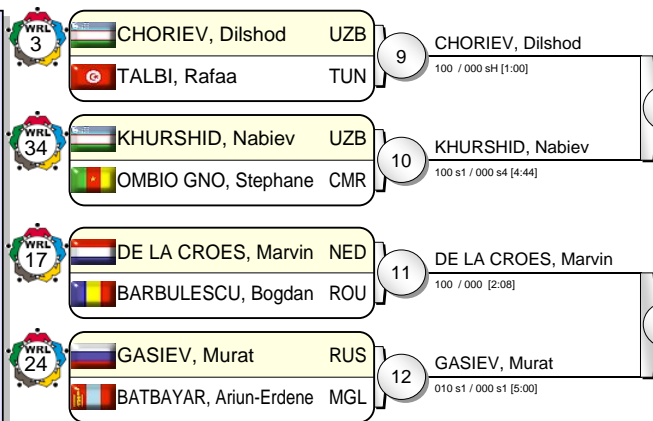

Pool D

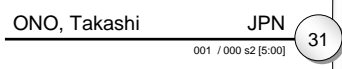
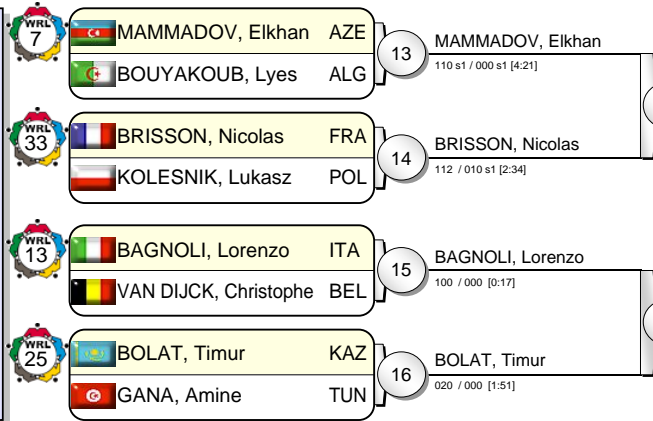

## Results

- |                         |     |  |
|-------------------------|-----|--|
| 1. ONO, Takashi         | JPN |  |
| 2. MAMMADOV, Elkhan     | AZE |  |
| 3. LIPARTELIANI, Varlam | GEO |  |
| 3. GASIEV, Murat        | RUS |  |
| 5. RANDL, Milan         | SVK |  |
| 5. SYNYAVSKY, Vadym     | UKR |  |
| 5. KHURSHID, Nabiev     | UZB |  |
| 5. BAGNOLI, Lorenzo     | ITA |  |





# IJF Grand Prix Tunis 2010

(TUN Tunis, 07-09 May 2010)

# -100 kg

26 Judoka

Pool A

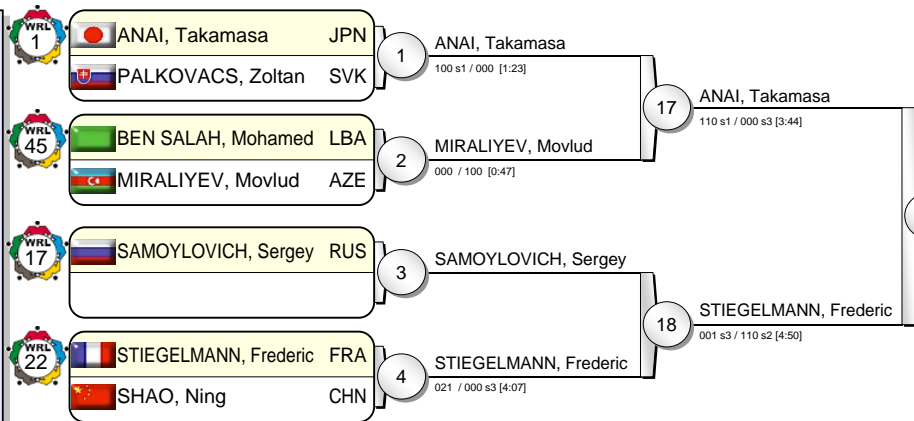

Pool B

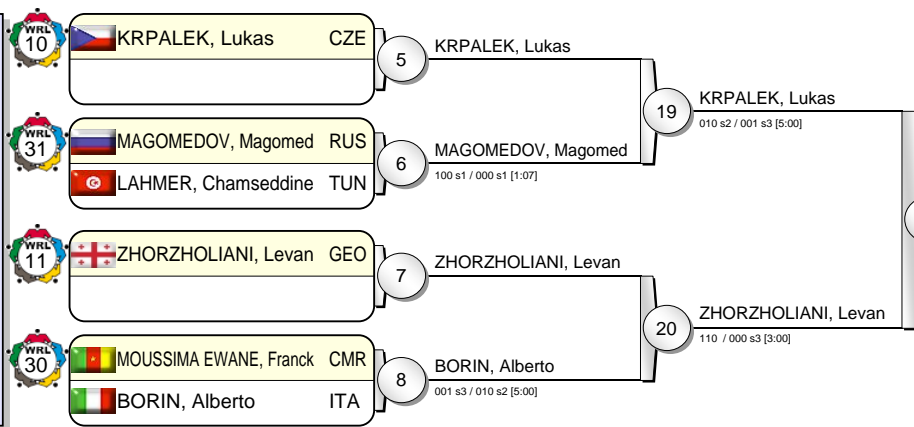

BIADULIN, Yauhen (BLR) vs [ ] - 0:43

Pool C

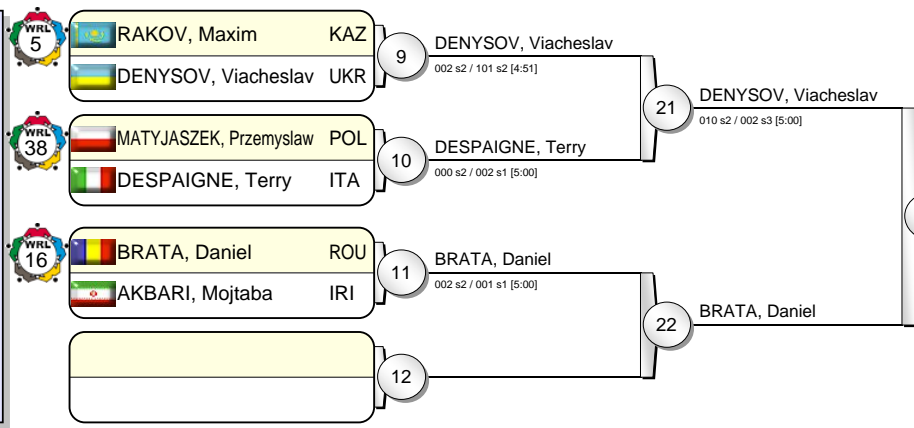

Pool D

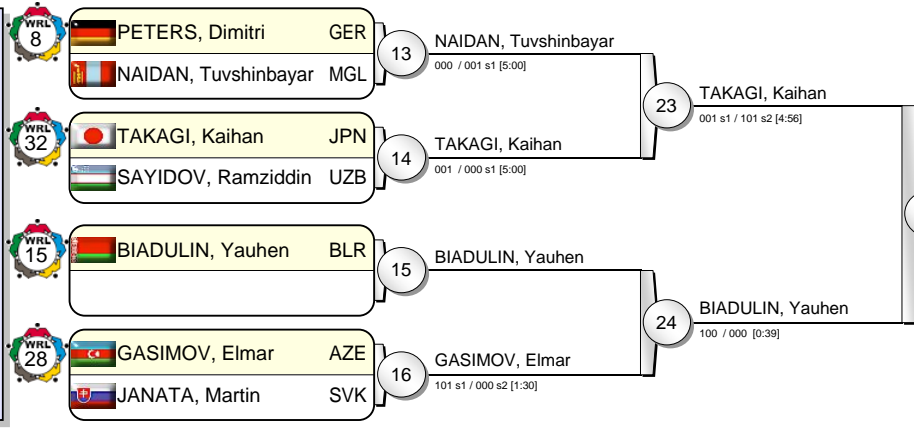

## Results

- |    |                       |     |  |
|----|-----------------------|-----|--|
| 1. | BIADULIN, Yauhen      | BLR |  |
| 2. | STIEGELMANN, Frederic | FRA |  |
| 3. | ZHORZHOLIANI, Levan   | GEO |  |
| 3. | DENYSOV, Viacheslav   | UKR |  |
| 5. | ANAI, Takamasa        | JPN |  |
| 5. | KRPALEK, Lukas        | CZE |  |
| 5. | BRATA, Daniel         | ROU |  |
| 5. | TAKAGI, Kaihan        | JPN |  |





# IJF Grand Prix Tunis 2010

(TUN Tunis, 07-09 May 2010)

# +100 kg

21 Judoka

Pool A

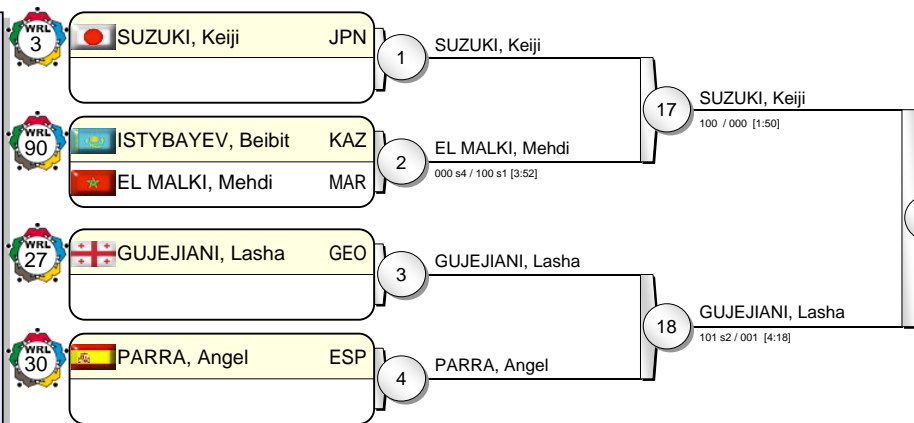

Pool B

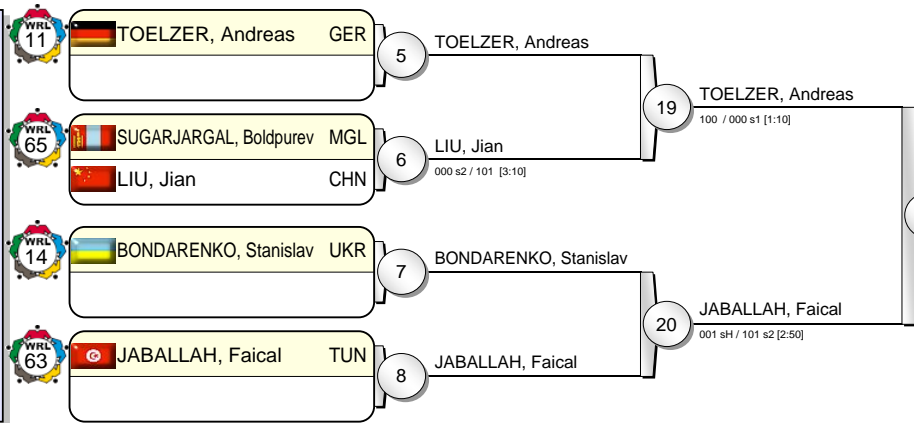

Pool C

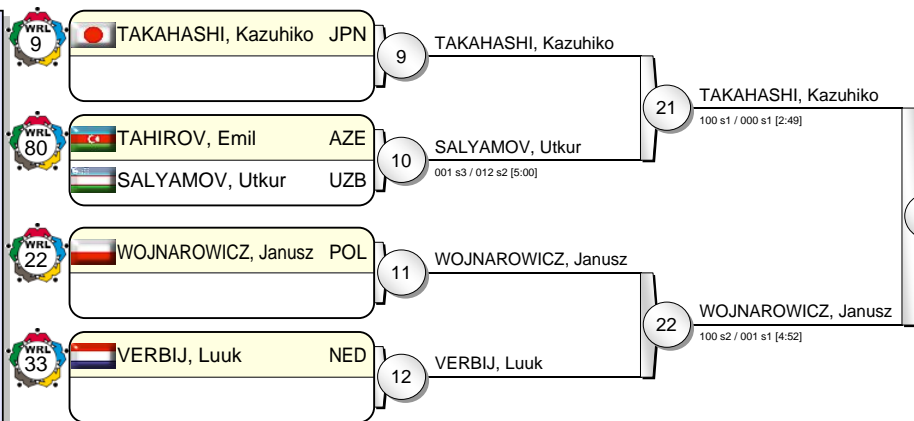

Pool D

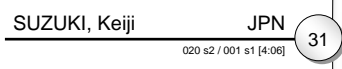
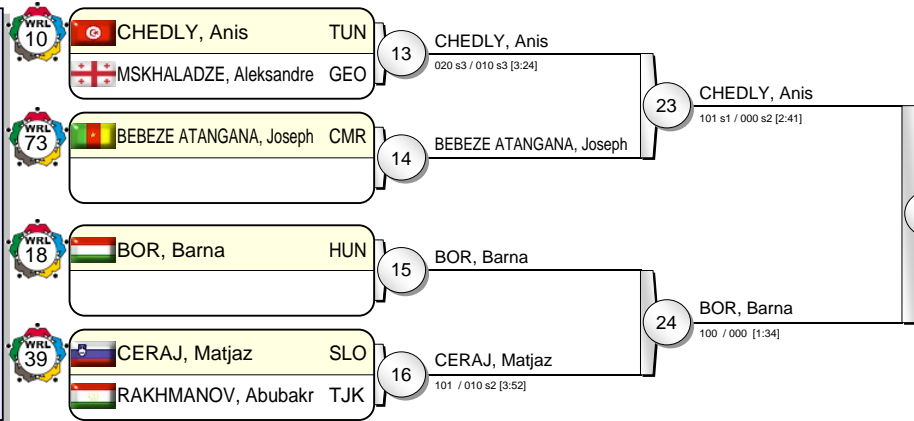

## Results

- |                        |     |  |
|------------------------|-----|--|
| 1. SUZUKI, Keiji       | JPN |  |
| 2. BOR, Barna          | HUN |  |
| 3. TOELZER, Andreas    | GER |  |
| 3. TAKAHASHI, Kazuhiko | JPN |  |
| 5. GUJEJIANI, Lasha    | GEO |  |
| 5. JABALLAH, Faical    | TUN |  |
| 5. WOJNAROWICZ, Janusz | POL |  |
| 5. CHEDLY, Anis        | TUN |  |





# IJF Grand Prix Tunis 2010

(TUN Tunis, 07-09 May 2010)

# -48 kg

18 Judoka

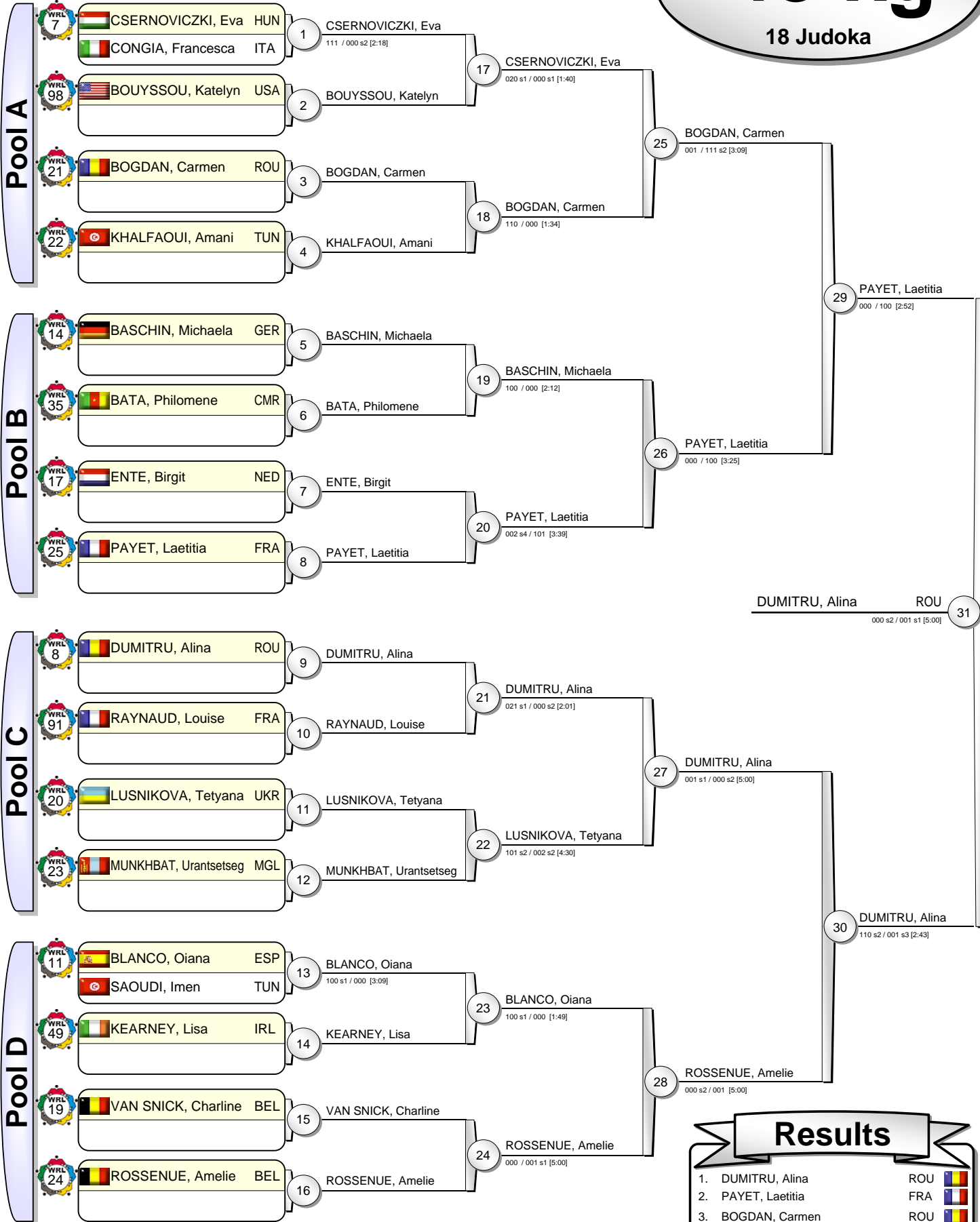

## Results

- |    |                    |     |  |
|----|--------------------|-----|--|
| 1. | DUMITRU, Alina     | ROU |  |
| 2. | PAYET, Laetitia    | FRA |  |
| 3. | BOGDAN, Carmen     | ROU |  |
| 3. | ROSSENUUE, Amelie  | BEL |  |
| 5. | CSERNOVICZKI, Eva  | HUN |  |
| 5. | BASCHIN, Michaela  | GER |  |
| 5. | LUSNIKOVA, Tetyana | UKR |  |
| 5. | BLANCO, Oiana      | ESP |  |





# IJF Grand Prix Tunis 2010

(TUN Tunis, 07-09 May 2010)

# -52 kg

20 Judoka

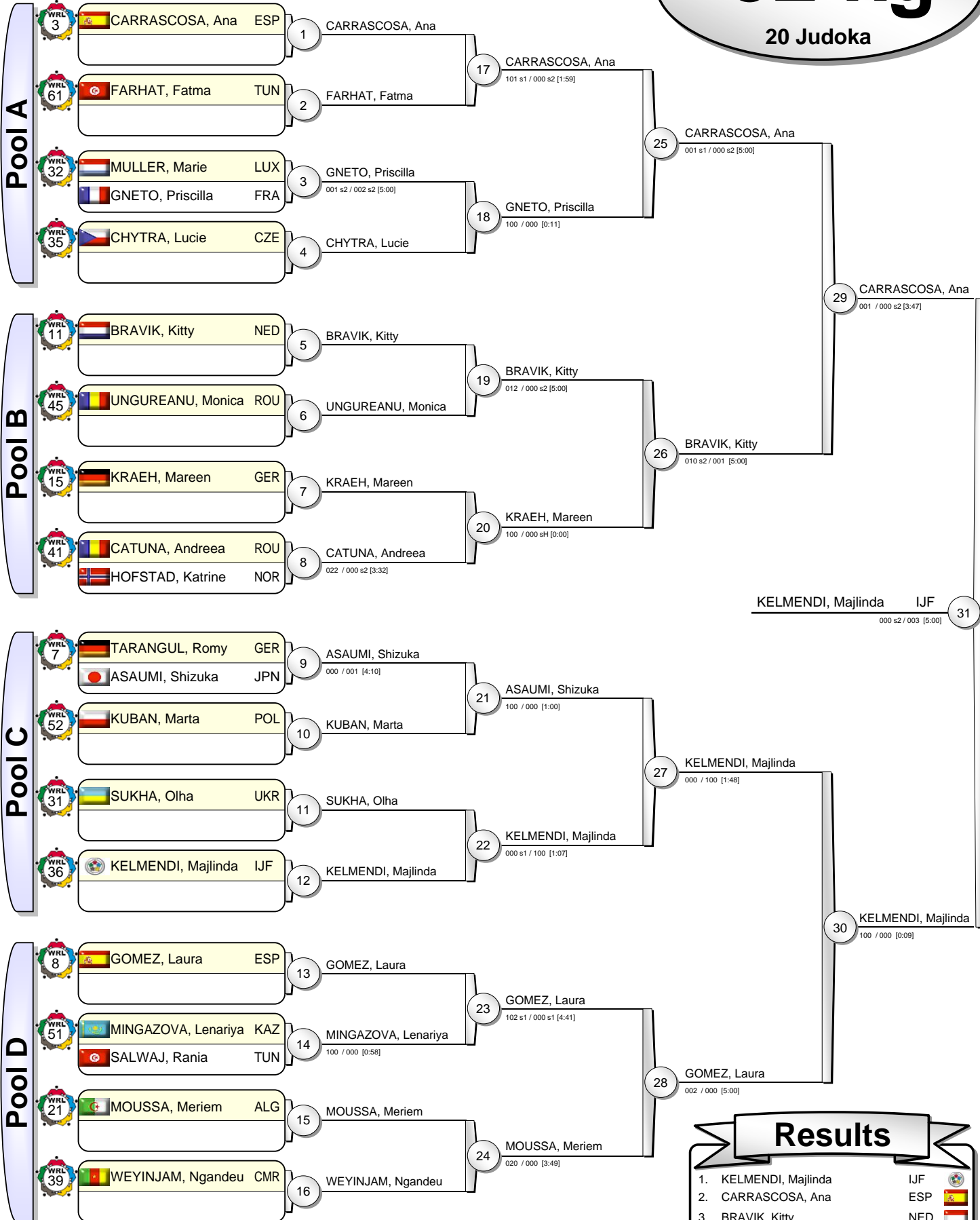

KELMENDI, Majlinda IJF 31  
000 s2 / 003 [5:00]

## Results

- |                       |     |  |
|-----------------------|-----|--|
| 1. KELMENDI, Majlinda | IJF |  |
| 2. CARRASCOSA, Ana    | ESP |  |
| 3. BRAVIK, Kitty      | NED |  |
| 3. GOMEZ, Laura       | ESP |  |
| 5. GNETO, Priscilla   | FRA |  |
| 5. KRAEH, Mareen      | GER |  |
| 5. ASAUMI, Shizuka    | JPN |  |
| 5. MOUSSA, Meriem     | ALG |  |





# IJF Grand Prix Tunis 2010

(TUN Tunis, 07-09 May 2010)

# -57 kg

18 Judoka

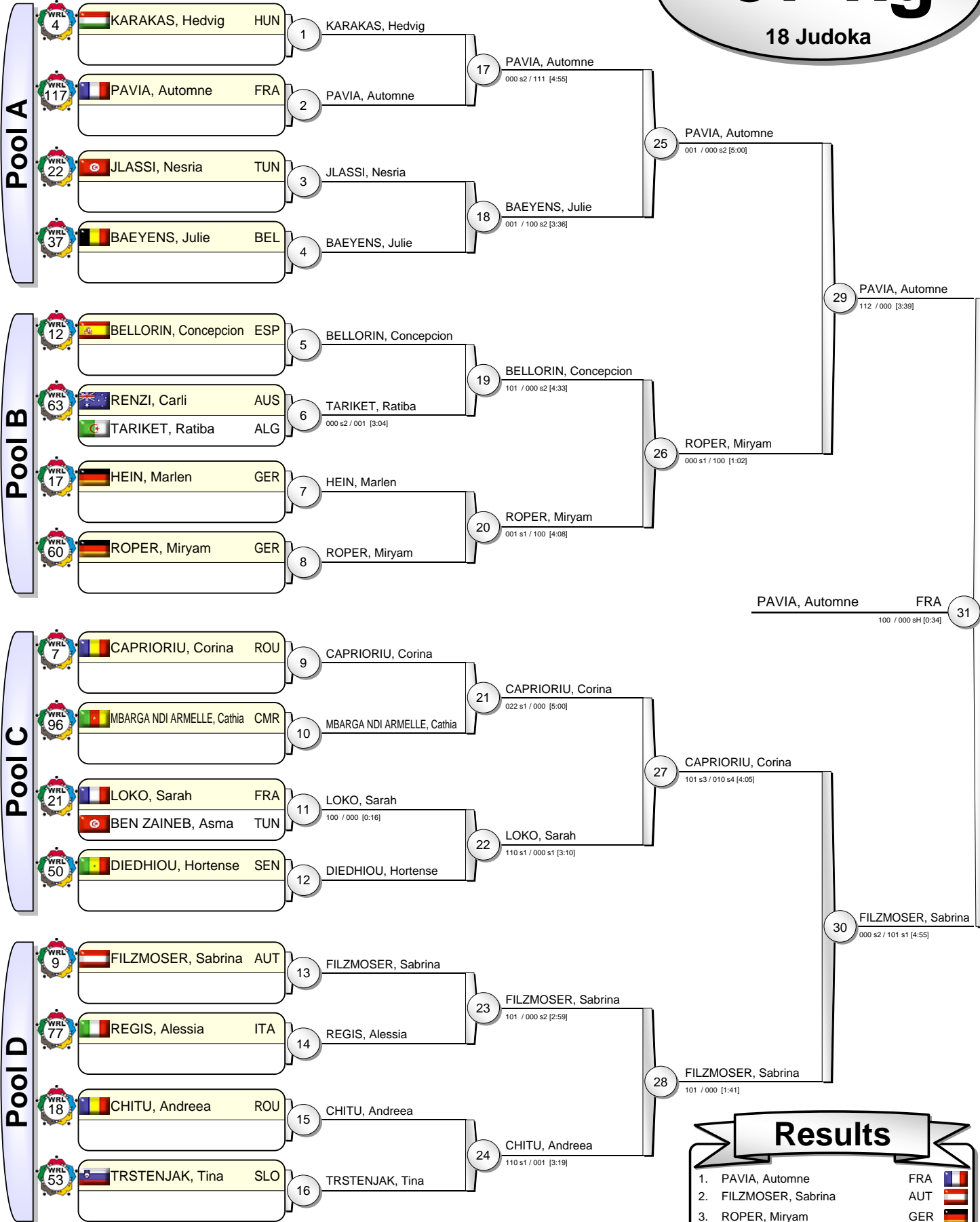

PAVIA, Automne FRA 31  
100 / 000 sH [0:34]

## Results

- |                         |     |  |
|-------------------------|-----|--|
| 1. PAVIA, Automne       | FRA |  |
| 2. FILZMOSER, Sabrina   | AUT |  |
| 3. ROPER, Miryam        | GER |  |
| 3. CAPRIORIU, Corina    | ROU |  |
| 5. BAEYENS, Julie       | BEL |  |
| 5. BELLORIN, Concepcion | ESP |  |
| 5. LOKO, Sarah          | FRA |  |
| 5. CHITU, Andreea       | ROU |  |





# IJF Grand Prix Tunis 2010

(TUN Tunis, 07-09 May 2010)

# -63 kg

20 Judoka

Pool A

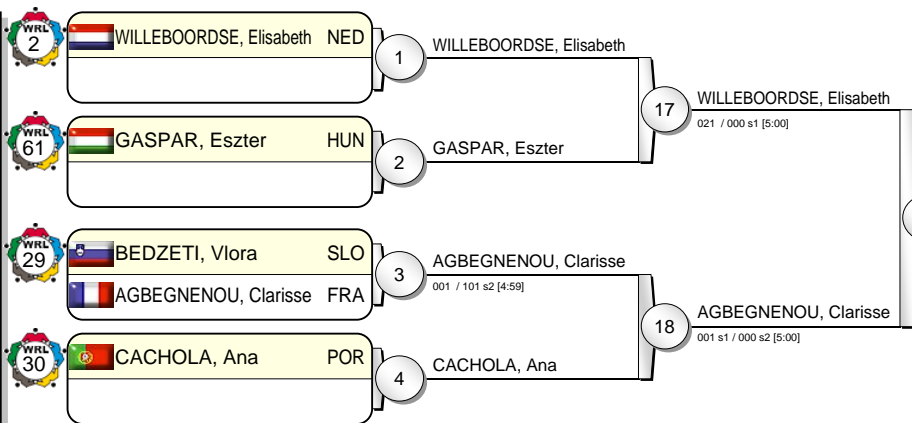

Pool B

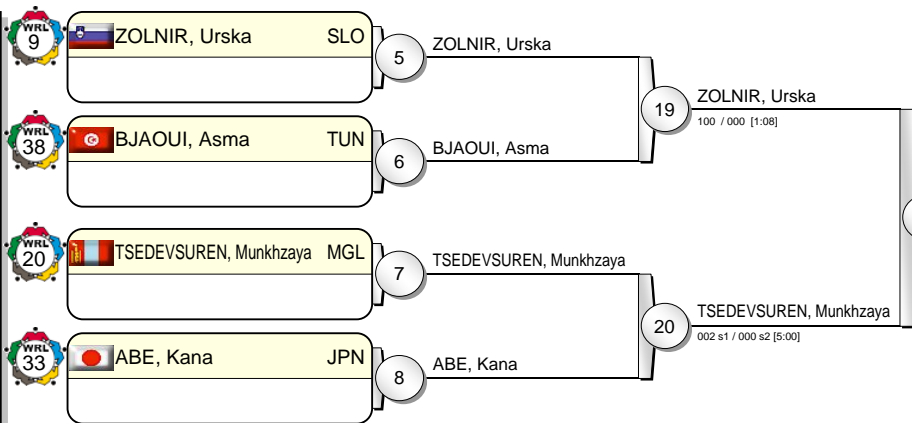

Pool C

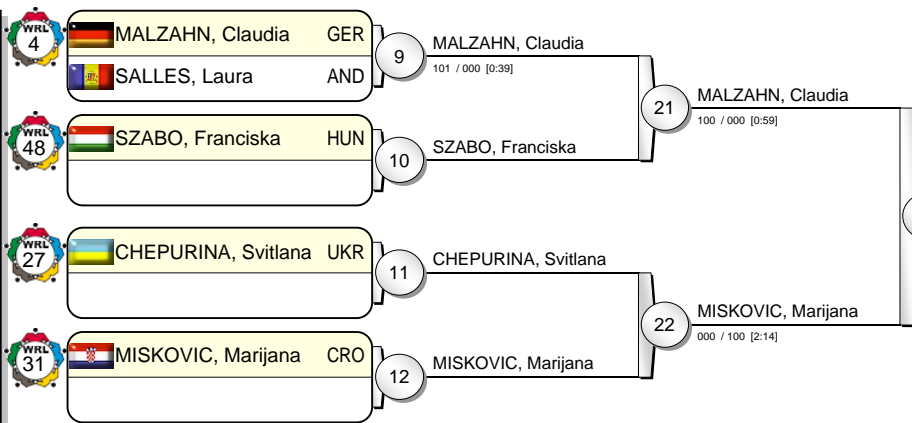

Pool D

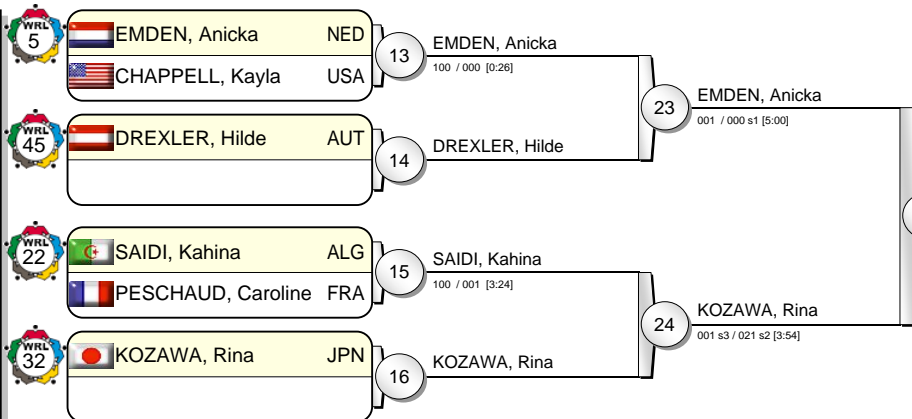

MALZAHN, Claudia GER 31  
000 s1 / 110 [2:07]

## Results

- MALZAHN, Claudia GER
- WILLEBOORDSE, Elisabeth NED
- ZOLNIR, Urska SLO
- EMDEN, Anicka NED
- AGBEGNEOU, Clarisse FRA
- TSEDEVSUREN, Munkhzaya MGL
- MISKOVIC, Marijana CRO
- KOZAWA, Rina JPN





# IJF Grand Prix Tunis 2010

(TUN Tunis, 07-09 May 2010)

# -70 kg

17 Judoka

Pool A

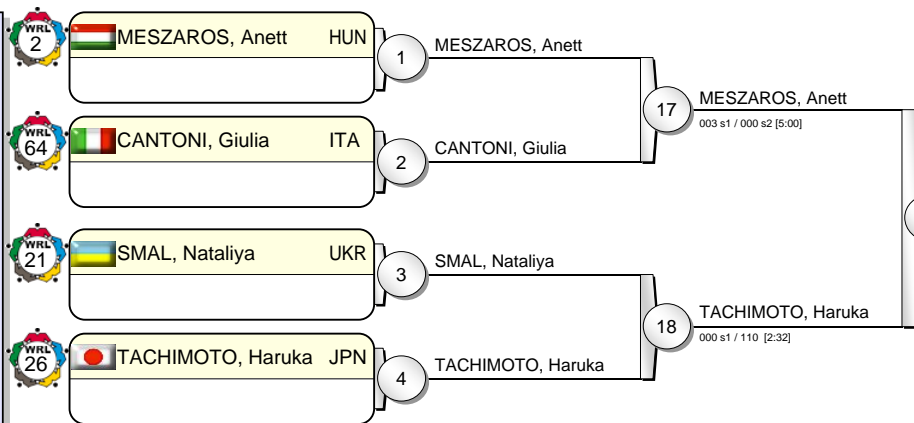

Pool B

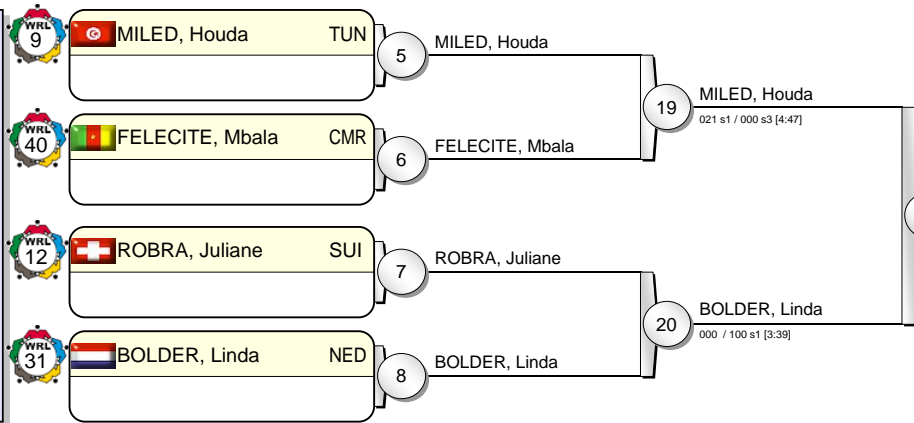

Pool C

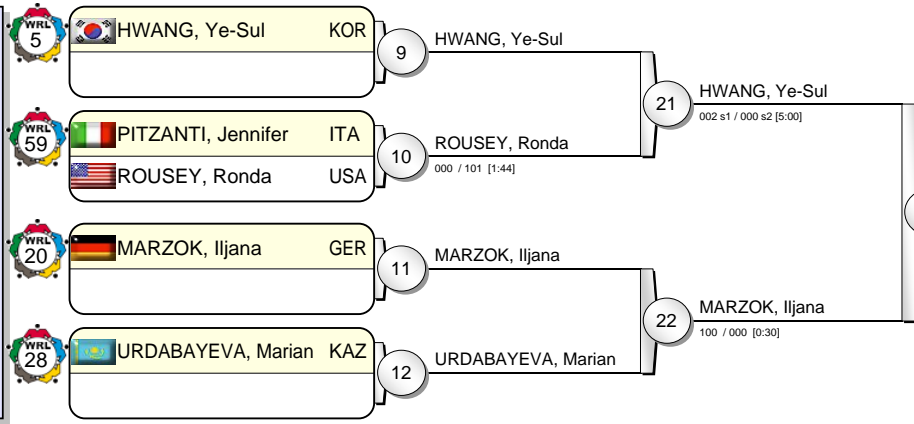

Pool D

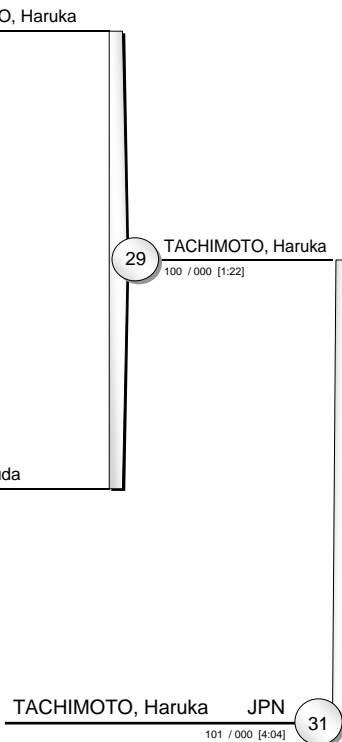
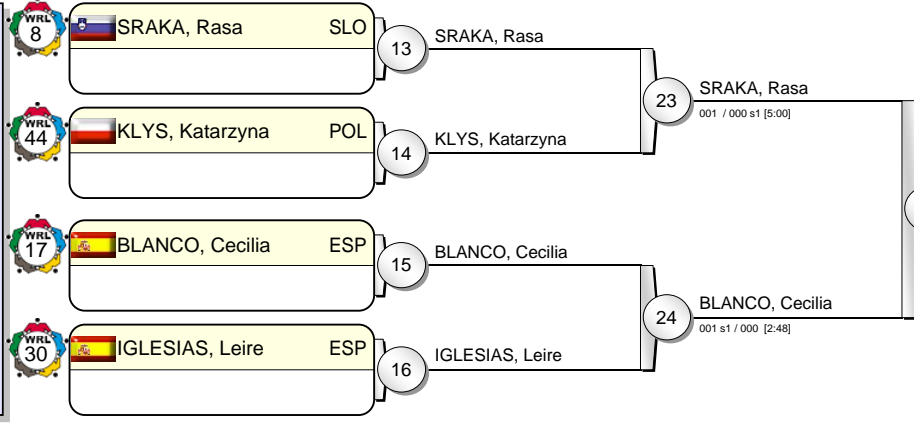

TACHIMOTO, Haruka JPN 101 / 000 [4:04]

## Results

- |                      |     |  |
|----------------------|-----|--|
| 1. TACHIMOTO, Haruka | JPN |  |
| 2. SRAKA, Rasa       | SLO |  |
| 3. MILED, Houda      | TUN |  |
| 3. MARZOK, Ijlana    | GER |  |
| 5. MESZAROS, Anett   | HUN |  |
| 5. BOLDER, Linda     | NED |  |
| 5. HWANG, Ye-Sul     | KOR |  |
| 5. BLANCO, Cecilia   | ESP |  |





# IJF Grand Prix Tunis 2010

(TUN Tunis, 07-09 May 2010)

# -78 kg

18 Judoka

Pool A

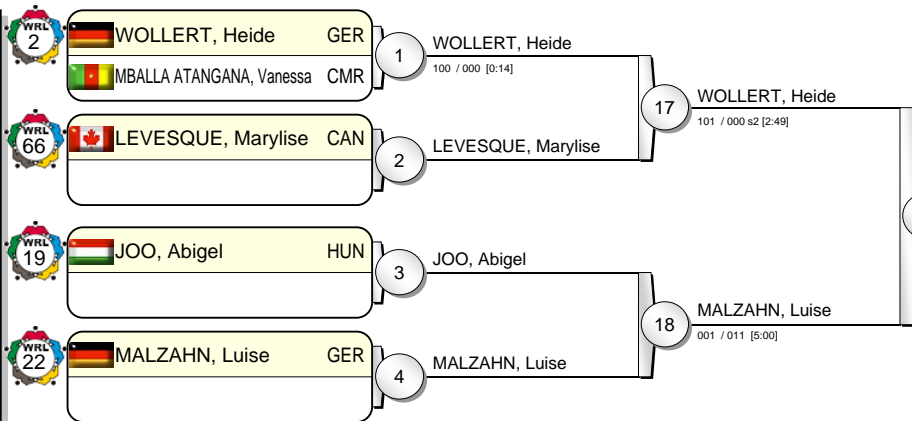

Pool B

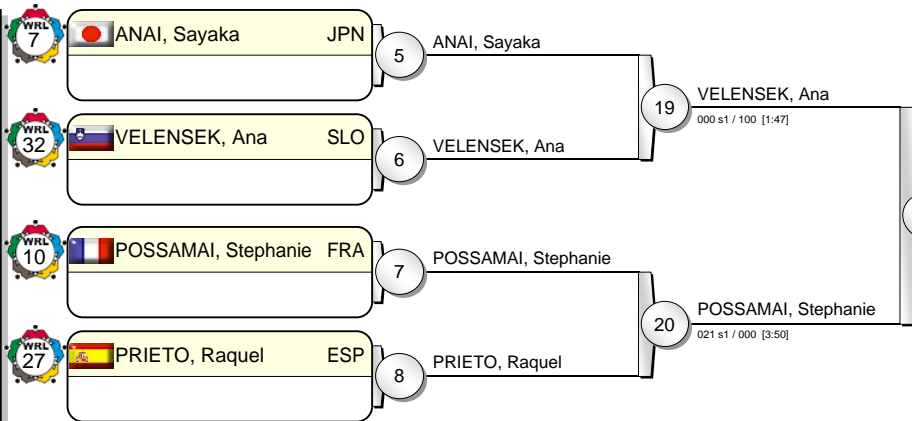

Pool C

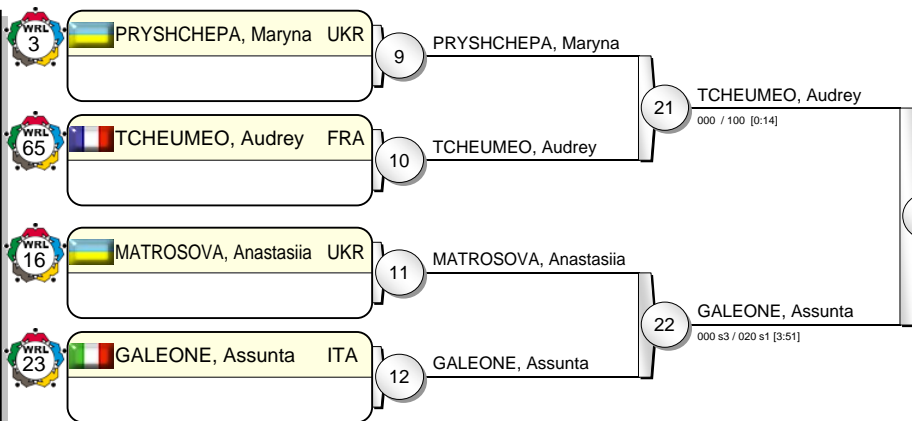

Pool D

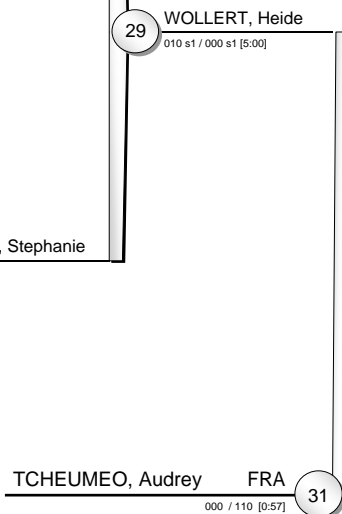
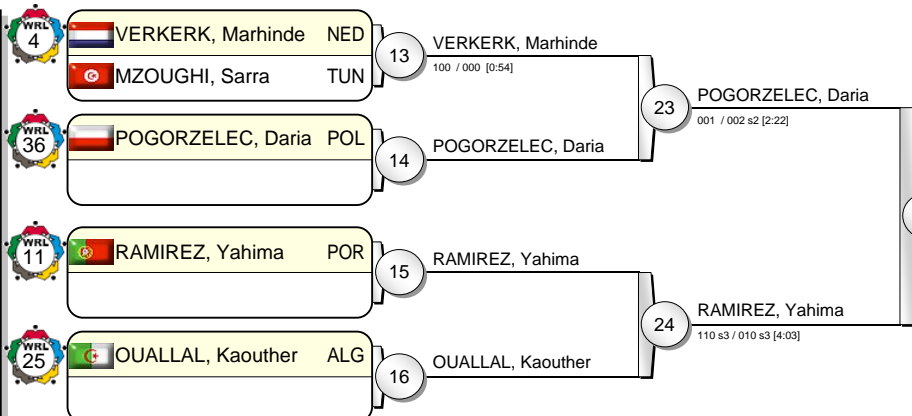

TCHEUMEO, Audrey FRA 31  
000 / 110 [0:57]

## Results

1. TCHEUMEO, Audrey FRA
2. WOLLERT, Heide GER
3. POSSAMAI, Stephanie FRA
3. POGORZELEC, Daria POL
5. MALZAHN, Luise GER
5. VELENSEK, Ana SLO
5. GALEONE, Assunta ITA
5. RAMIREZ, Yahima POR





# IJF Grand Prix Tunis 2010

(TUN Tunis, 07-09 May 2010)

# +78 kg

14 Judoka

Pool A

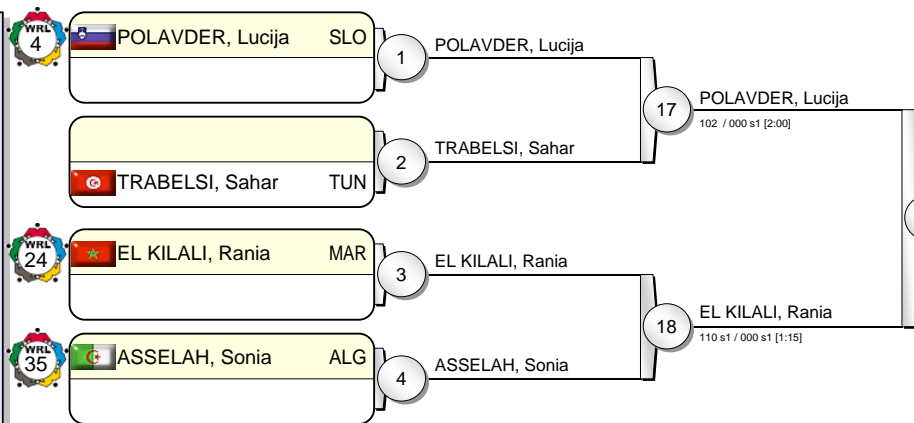

Pool B

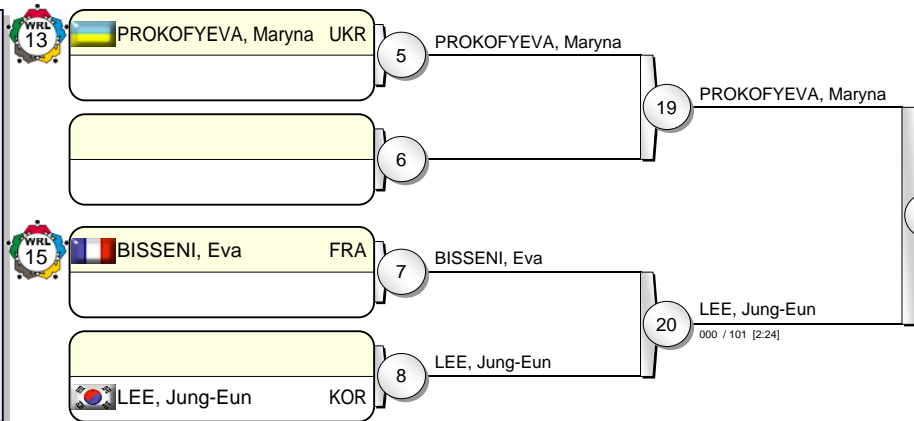

Pool C

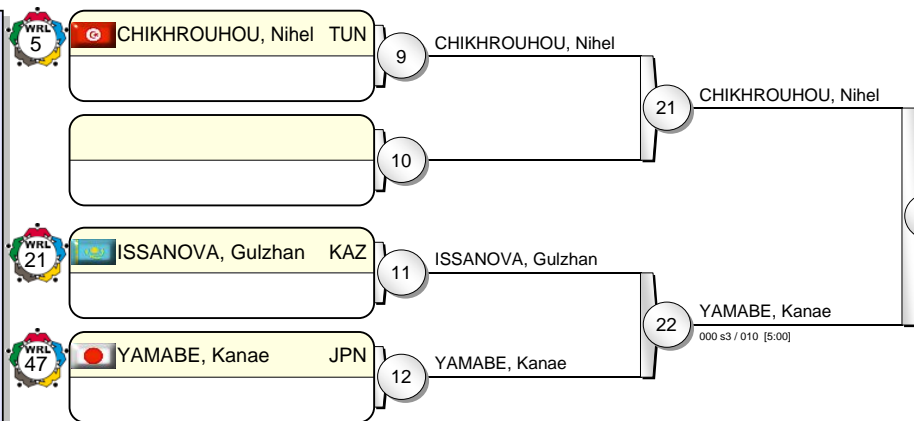

Pool D

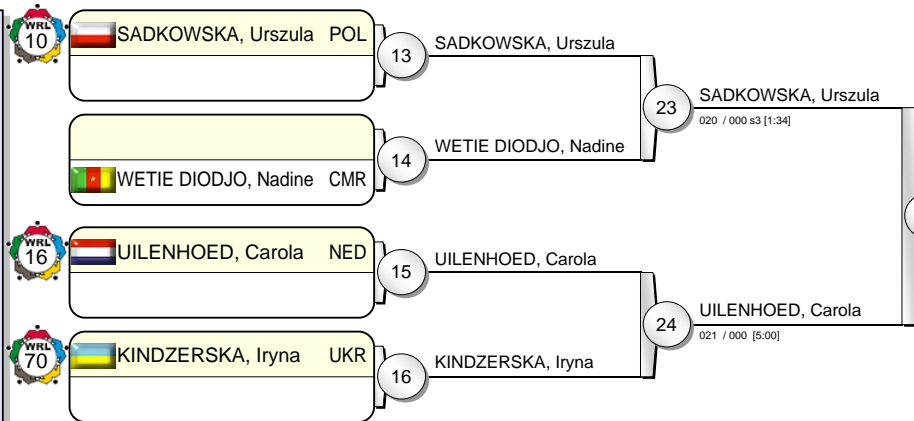

POLAVDER, Lucija SLO 31  
012 s1 / 000 s2 [5:00]

## Results

- |                       |     |  |
|-----------------------|-----|--|
| 1. POLAVDER, Lucija   | SLO |  |
| 2. CHIKHROUHOU, Nihel | TUN |  |
| 3. LEE, Jung-Eun      | KOR |  |
| 3. SADKOWSKA, Urszula | POL |  |
| 5. EL KILALI, Rania   | MAR |  |
| 5. PROKOFYEVA, Maryna | UKR |  |
| 5. YAMABE, Kanae      | JPN |  |
| 5. UILENHOED, Carola  | NED |  |

